

DATA SHEET

FortiAP™ UTP Access Point Series

Available in:



Appliance

Unified Threat Protection Capable Access Points*



The FortiAP-U family offers a wide range of models with the additional power of FortiGuard services and the flexibility of dual 5 GHz support for Wi-Fi 6 APs. Perfect for everything from a large campus to hundreds of branch locations, the FortiAP-U family has a variety of form factors and performance levels. FortiAP-U access points are managed centrally by the integrated WLAN controller of any FortiGate® security appliance, through the FortiLAN Cloud provisioning and management portal, or through standalone controllers (FortiWLC). Protect your LAN Edge from the campus to the branch with these high capacity capable APs.

Product Offerings

802.11ax Wi-Fi 6

FAP-U431F
FAP-U433F 4×4 Indoor tri-radio dual 5G 11ax APs

FAP-U432F 4×4 Indoor/Outdoor tri-radio dual 5G 11ax APs

FAP-U231F 2×2 Indoor tri-radio dual 5G 11ax APs

FAP-U234F 2×2 Indoor/Outdoor tri-radio dual 5G 11ax APs

802.11ac (Wave 2) Wi-Fi 5

FAP-U421EV
FAP-U423EV 4×4 APs with dual radios

FAP-U422EV 4×4 Outdoor AP, with dual radios

FAP-U321EV
FAP-U323EV 3×3 Indoor dual-radio APs

802.11ac (Wave 1) Wi-Fi 5

FAP-U24JE 2×2 Wall jack AP with 4 GE ports



Ability to intelligently support integrated security controllers (FortiGate), and cloud management options with FortiGuard services at the edge; and establish a new benchmark in flexibility, performance, and security.



Wi-Fi 6 technology with data rates of up to 4.8 Gbps and OFDMA improves client throughput and overall network efficiency.



Integrates with Fortinet's Security Fabric, providing unparalleled cybersecurity protection at the network edge.

* Select models only, see listings

HIGHLIGHTS

Fortinet UTP access points are designed to support a variety of deployments from branches, to medium to large offices, schools, universities, hospitals, hotels, and large retail stores. These access points can serve such a wide range of applications because they can be managed by any of Fortinet’s control and management. By supporting UTP services at the edge, deployments have the flexibility to enable security services wherever they need them in their network.

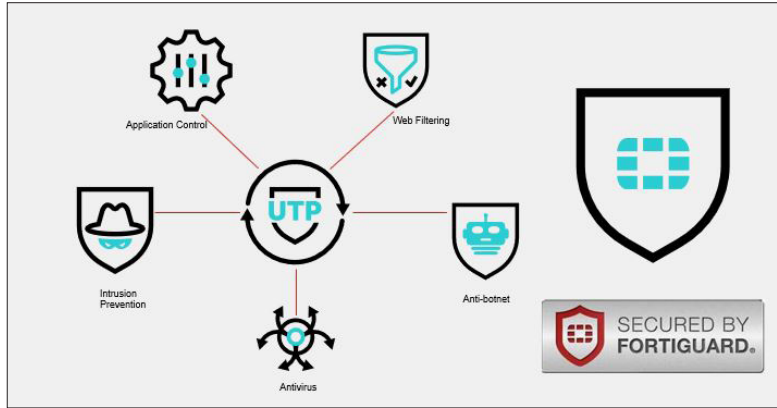

Figure 1 — FortiGuard Services

Education

The Education sector is at rising risk from cyber attacks. In conjunction with requirements to protect minors from inappropriate materials, this can make deploying wireless a challenge. Our integrated secure wireless controller (FortiGate) ensures secure student access to learning resources while FortiGuard services provides cybersecurity protection.

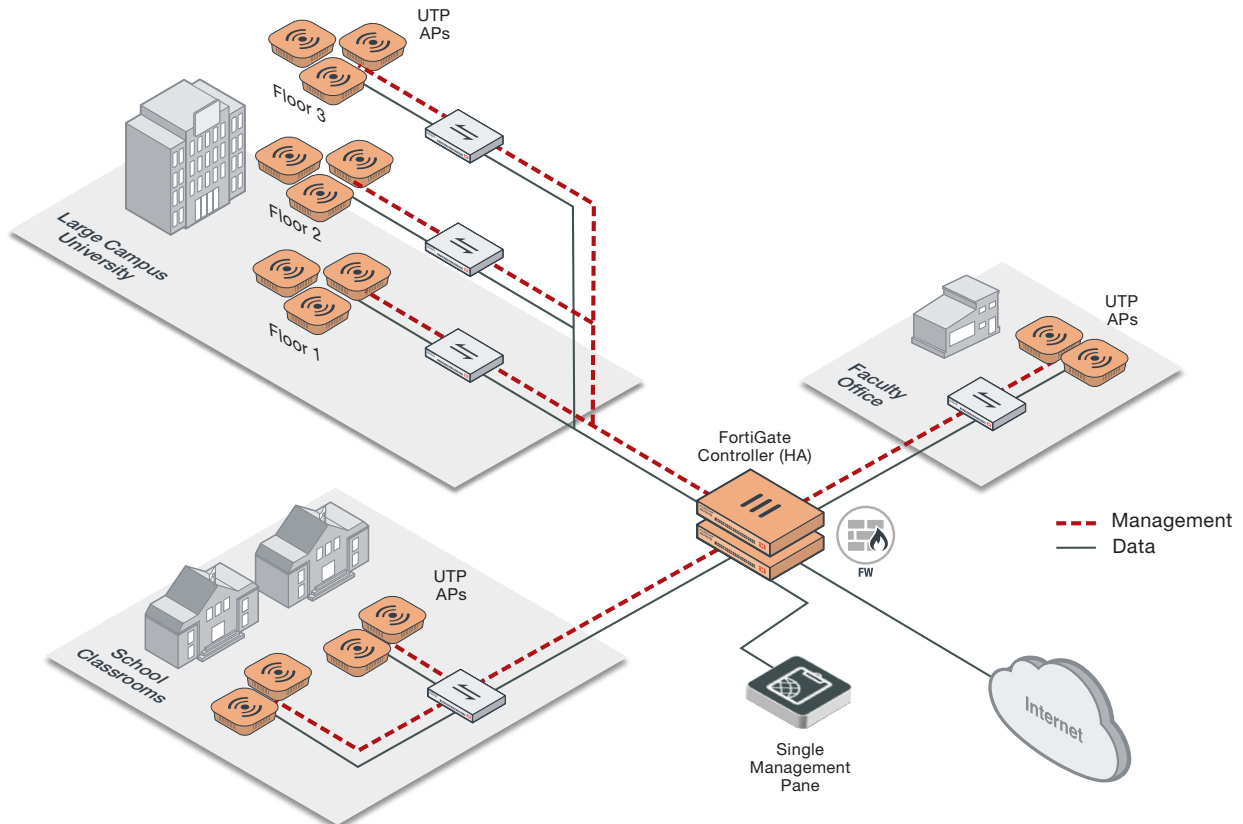

Figure 2 — Educational organizations with UTP APs managed by on-premise or centralized FortiGate controllers.



HIGHLIGHTS

Healthcare

Patient safety is priority one. Fortinet UTP APs empower hospitals to improve patient safety by enabling life-critical applications such as telemetry requiring low bandwidth but exceptionally high reliability. Our dedicated wireless controllers (integrated WLAN controller of any FortiGate security appliance) connected to our access points ensures patient safety remains paramount, while providing improved performance for wireless enabled medical devices.

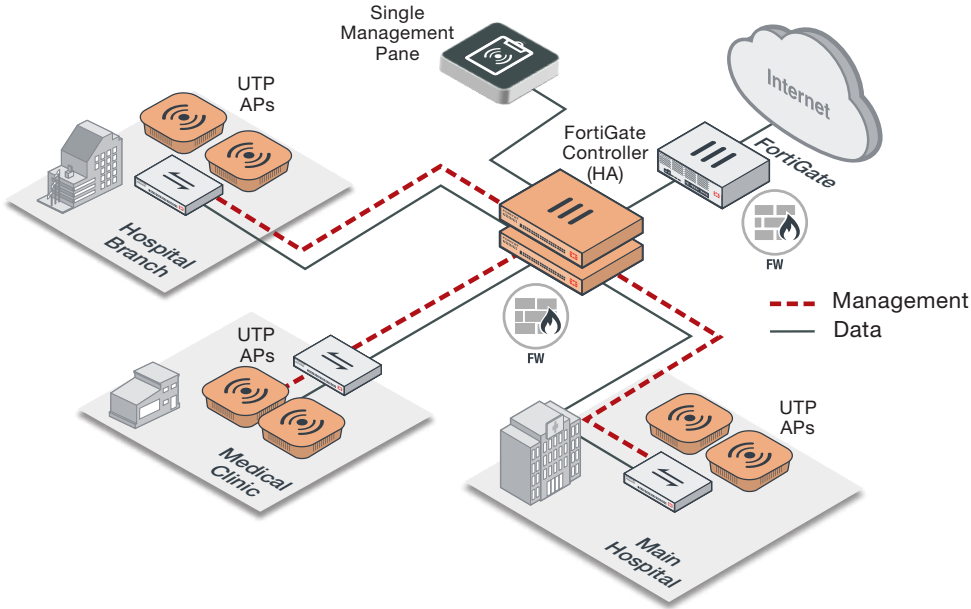

Figure 3 — Healthcare organizations with UTP APs managed by on-premise or centralized FortiGate acting as a Wireless controller.

Small/Medium Business

Retailers can streamline Wi-Fi store deployments through the combination of UTP APs and FortiLAN Cloud management. This scenario, in combination with FortiDeploy for zero-touch provisioning and deployment, offers a cost-effective and secure solution for retail IT.

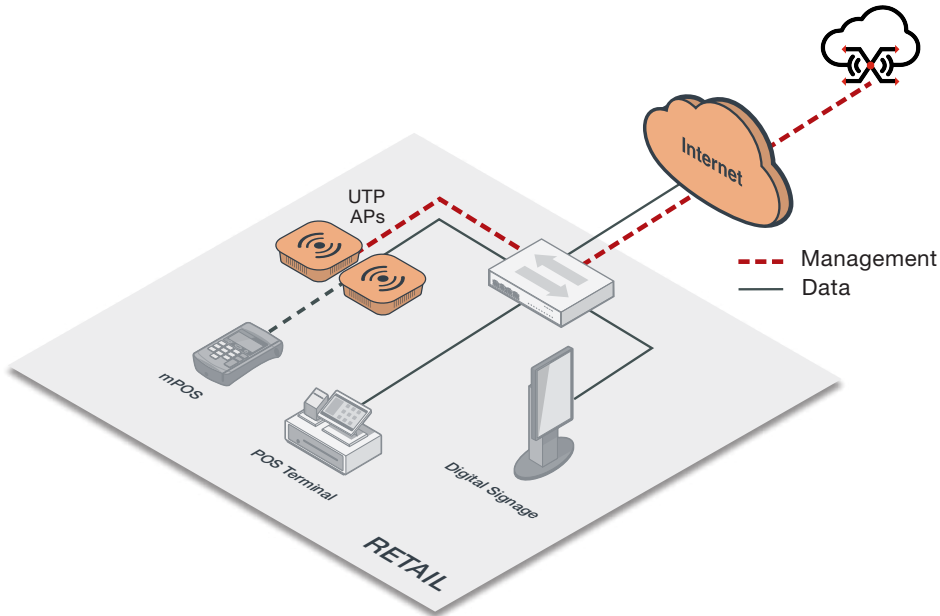

Figure 4 — Retail store with UTP APs managed by FortiLAN Cloud.



HIGHLIGHTS

FortiAP U431F and U433F

These enterprise class Wi-Fi6 (802.11ax) indoor APs provide three radios. These top-of-the-line access points provide OFDMA, a 2.5 Gigabit Ethernet port plus an additional 1 Gbps Ethernet port for PoE diversity. The APs can be configured for dual 5 GHz band access while still providing coverage for devices on the 2.4 GHz band, or can be configured to offer dedicated scanning. The integrated BLE radio can be used for beacons and locationing applications.



 **802.11ax | Tri-Radio 5 GHz + 5 GHz + 2.4 GHz or 5 GHz + 2.4 GHz + scanning | 10 Antennas**

 **4x4 MIMO | Up to 4,804 Mbps + 4,804 Mbps + 300 Mbps**

SPECIFICATIONS

	FORTIAP-U431F	FORTIAP-U433F
Hardware		
Hardware Type	Indoor AP	Indoor AP
Number of Radios	3 + 1 BLE	3 + 1 BLE
Number of Antennas	10 Internal + 1 BLE Internal	10 External (RP-SMA) + 1 BLE Internal
Antenna Type and Peak Gain	PIFA: 4 dBi for 2.4 GHz, 6 dBi for 5 GHz	Dipole: 3.5 dBi for 2.4 GHz, 5 dBi for 5 GHz
Frequency Bands (GHz)	2.400–2.4835, 5.150–5.250, 5.250–5.350, 5.470–5.725, 5.725–5.850	2.400–2.4835, 5.150–5.250, 5.250–5.350, 5.470–5.725, 5.725–5.850
Radio 1 Capabilities	5.0 GHz a/n/ac/ax (4x4:4 stream) 20/40/80/160 MHz (64/256/1024 QAM)	5.0 GHz a/n/ac/ax (4x4:4 stream) 20/40/80/160 MHz (64/256/1024 QAM)
Radio 2 Capabilities	2.4 GHz or 5.0 GHz (high band) a/b/g/n/ac/ax (4x4:4 stream) 20/40/80/160 MHz (64/256/1024 QAM)	2.4 GHz or 5.0 GHz (high band) a/b/g/n/ac/ax (4x4:4 stream) 20/40/80/160 MHz (64/256/1024 QAM)
Radio 3 Capabilities	2.4/5.0 GHz dual band b/g/n/ac (2x2:2 stream) 20/40 MHz (64 QAM)	2.4/5.0 GHz dual band b/g/n/ac (2x2:2 stream) 20/40 MHz (64 QAM)
Maximum Data Rate	Radio 1: up to 4,804 Mbps Radio 2: up to 4,804 Mbps Radio 3: up to 300 Mbps	Radio 1: up to 4,804 Mbps Radio 2: up to 4,804 Mbps Radio 3: up to 300 Mbps
Bluetooth Low Energy Radio	Bluetooth scanning and iBeacon advertisement @ 4 dBm max TX power	Bluetooth scanning and iBeacon advertisement @ 4 dBm max TX power
Interfaces	1x 10/100/1000/2500 Base-T RJ45, 1x 10/100/1000 Base-T RJ45, 1x Type A USB, 1x RS-232 RJ45 Serial Port	1x 10/100/1000/2500 Base-T RJ45, 1x 10/100/1000 Base-T RJ45, 1x Type A USB, 1x RS-232 RJ45 Serial Port
Power over Ethernet (PoE)	Dual redundant PoE power ports with support for IEEE 802.3at or dual 802.3af power	Dual redundant PoE power ports with support for IEEE 802.3at or dual 802.3af power
Simultaneous SSIDs	Up to 16 (14 if background scanning enabled)	Up to 16 (14 if background scanning enabled)
EAP Type(s)	EAP-TLS, EAP-TTLS/MSCSHAPv2, PEAPv0/EAP-MSCHAPv2, PEAPv1/EAP-GTC, EAP-SIM, EAP-AKA, EAP-FAST	EAP-TLS, EAP-TTLS/MSCSHAPv2, PEAPv0/EAP-MSCHAPv2, PEAPv1/EAP-GTC, EAP-SIM, EAP-AKA, EAP-FAST
User/Device Authentication	WPA™, WPA2™, and WPA3™ with 802.1x or Preshared key, WEP, Web Captive Portal, MAC blacklist and allowlist	WPA™, WPA2™, and WPA3™ with 802.1x or Preshared key, WEP, Web Captive Portal, MAC blacklist and allowlist
Maximum Tx Power (Conducted)	Radio 1: 5 GHz: 24 dBm / 251 mW (4 chains combined)* Radio 2: 2.4 GHz: 26 dBm / 398 mW (4 chains combined)* 5 GHz: 24 dBm / 251 mW (4 chains combined)* Radio 3: 2.4 GHz: 22 dBm / 158 mW (2 chains combined)*	Radio 1: 5 GHz: 24 dBm / 251 mW (4 chains combined)* Radio 2: 2.4 GHz: 26 dBm / 398 mW (4 chains combined)* 5 GHz: 24 dBm / 251 mW (4 chains combined)* Radio 3: 2.4 GHz: 22 dBm / 158 mW (2 chains combined)*
Kensington Lock	Yes	Yes
IEEE Standards	802.11a, 802.11b, 802.11d, 802.11e, 802.11g, 802.11h, 802.11i, 802.11j, 802.11k, 802.11n, 802.11r, 802.11v, 802.11w, 802.11ac, 802.1Q, 802.1X, 802.3ad, 802.3af, 802.3at, 802.3az, 802.11ax, 802.3bz, Wi-Fi 6	802.11a, 802.11b, 802.11d, 802.11e, 802.11g, 802.11h, 802.11i, 802.11j, 802.11k, 802.11n, 802.11r, 802.11v, 802.11w, 802.11ac, 802.1Q, 802.1X, 802.3ad, 802.3af, 802.3at, 802.3az, 802.3bz Wi-Fi 6
SSID Types Supported	Local-Bridge, Mesh, & Tunnel	Local-Bridge, Mesh, & Tunnel
Per Radio Client Capacity	Up to 512 per Radio1 and Radio2	Up to 512 per Radio1 and Radio2
Cellular Co-existence**	Yes	Yes
Reset Button	Yes	Yes
Threat Protection Capable	Yes	Yes

* Frequency selection and power may be restricted to abide by regional regulatory compliance laws.

** Additional filtration added to reduce interference in 2.4GHz band from nearby cellular equipment.



SPECIFICATIONS

	FORTIAP-U431F	FORTIAP-U433F
LED Off Mode	Yes	Yes
Advanced 802.11 Features		
Transmit Beam Forming (TxBF)	Yes	Yes
Low-Density Parity Check (LDPC) Encoding	Yes	Yes
Maximum Likelihood Demodulation (MLD)	Yes	Yes
Maximum Ratio Combining (MRC)	Yes	Yes
A-MPDU and A-MSDU Packet Aggregation	Yes	Yes
OFDMA	Yes (UL and DL)	Yes (UL and DL)
2.4 GHz OFDMA	Yes	Yes
Spatial Reuse (BSS Coloring)	Yes	Yes
HE-MU-MIMO	Yes	Yes
UL-MU-MIMO 802.11ax mode	Yes	Yes
UL-MU-MIMO 802.11ac mode	No	No
DL-MU-MIMO	Yes	Yes
Enhanced Target Wake Time (TWT)	Yes	Yes
ZeroWait DFS /Agile DFS	Yes	Yes
Wireless Monitoring Capabilities		
Rogue Scan Radio Modes	Background, Dedicated	Background, Dedicated
WIPS / WIDS Radio Modes	Background, Dedicated (recommended)	Background, Dedicated (recommended)
Packet Sniffer Mode	Yes	Yes
Spectrum Analyzer	Yes	Yes
Dimensions		
Length x Width x Height	8.46 × 8.46 × 2.26 inches (215 × 215 × 57.5 mm)	8.46 × 8.46 × 2.26 inches (215 × 215 × 57.5 mm)
Weight	1.0 lb (0.453 kg)	1.0 lb (0.453 kg)
Package (shipping) Weight	1.8 lbs (0.82 kg)	1.8 lbs (0.82 kg)
Mounting Options	Ceiling, T-Rail, and Wall	Ceiling, T-Rail, and Wall
Included Accessories	Mount kits for Ceiling, T-Rail, and Wall	Mount kits for Ceiling, T-Rail, and Wall, 10x dipole antennas
Environment		
Power Supply	GPI-130, or 2x GPI-115 GPI-130, or 2x GPI-115, or AC adapter SP-FAP43F-PA-X-5	GPI-130, or 2x GPI-115 GPI-130, or 2x GPI-115, or AC adapter SP-FAP43F-PA-X-5
Power Consumption (Maximum)	24.5 W	24.5 W
Humidity	10–90% Non-Condensed 5–90% Condensed	10–90% Non-Condensed 5–90% Condensed
Operating / Storage Temperature	32–122°F (0–50°C) / -31–158°F (-35–70°C)	32–122°F (0–50°C) / -31–158°F (-35–70°C)
Directives	Low Voltage Directive • RoHS	Low Voltage Directive • RoHS
UL2043 Plenum Material	Yes	Yes
Mean Time Between Failures	>30 Years	>30 Years
IP Rating	—	—
Surge Protection Built In	—	—
Hit-less PoE Failover	Yes (802.3at only)	Yes (802.3at only)
Certifications		
Wi-Fi Alliance Certified	Yes	Yes
DFS	FCC, IC, CE, Japan, Taiwan, Korea, Brazil	FCC, IC, CE, Japan, Taiwan, Korea, Brazil
Warranty		
Limited Lifetime Warranty	Yes	Yes



FAP-U431F / FAP-U433F RF RX/TX PERFORMANCE TABLE

FORTIAP U431F AND U433F						
	Radio 1		Radio 2		Radio 3	
	Max Tx Power per transmit chain (dBm)	Rx Sensitivity per receiver chain (dBm)	Max Tx Power per transmit chain (dBm)	Rx Sensitivity per receiver chain (dBm)	Max Tx Power per transmit chain (dBm)	Rx Sensitivity per receiver chain (dBm)
2.4 GHz, 802.11b						
1 Mbps	20	-98	—	—	19	-96
11 Mbps	20	-89	—	—	19	-87
2.4 GHz, 802.11g						
6 Mbps	20	-94	—	—	19	-92
54 Mbps	20	-75	—	—	19	-73
2.4 GHz, 802.11n HT20						
MCS0	19	-93	—	—	18	-91
MCS7	17	-74	—	—	16	-72
2.4 GHz, 802.11n HT40						
MCS0	19	-92	—	—	18	-90
MCS7	17	-73	—	—	16	-71
2.4 GHz, 802.11ax HE20						
MCS0	18	-90	—	—	17	-88
MCS11	16	-71	—	—	15	-69
2.4 GHz, 802.11ax HE40						
MCS0	17	-88	—	—	16	-86
MCS11	15	-68	—	—	14	-66
5.0 GHz, 802.11a						
6 Mbps	20	-92	20	-92	—	—
54 Mbps	20	-72	20	-72	—	—
5.0 GHz, 802.11n HT20						
MCS0	20	-91	20	-91	—	—
MCS7	18	-72	18	-72	—	—
5.0 GHz, 802.11n HT40						
MCS0	20	-88	20	-88	—	—
MCS7	18	-69	18	-69	—	—
5.0 GHz, 802.11ac VHT20						
MCS0	20	-91	20	-91	—	—
MCS9	18	-67	18	-67	—	—
5.0 GHz, 802.11ac VHT40						
MCS0	20	-88	20	-88	—	—
MCS9	18	-62	18	-62	—	—
5.0 GHz, 802.11ac VHT80						
MCS0	19	-85	19	-85	—	—
MCS9	17	-59	17	-59	—	—
5.0 GHz, 802.11ac VHT160						
MCS0	16	-82	16	-82	—	—
MCS9	15	-56	15	-56	—	—
5.0 GHz, 802.11ax HE20						
MCS0	19	-90	19	-90	—	—
MCS11	17	-66	17	-66	—	—
5.0GHz, 802.11ac HE40						
MCS0	19	-87	19	-87	—	—
MCS11	17	-61	17	-61	—	—
5.0 GHz, 802.11ac HE80						
MCS0	18	-94	18	-94	—	—
MCS11	16	-58	16	-58	—	—



FAP-U431F / FAP-U433F RF RX/TX PERFORMANCE TABLE

FORTIAP U431F AND U433F						
	Radio 1		Radio 2		Radio 3	
	Max Tx Power per transmit chain (dBm)	Rx Sensitivity per receiver chain (dBm)	Max Tx Power per transmit chain (dBm)	Rx Sensitivity per receiver chain (dBm)	Max Tx Power per transmit chain (dBm)	Rx Sensitivity per receiver chain (dBm)
5.0 GHz, 802.11ac HE160						
MCS0	15	-81	15	-81	—	—
MCS11	14	-55	14	-55	—	—

Maximum capability of the hardware provided (excluding antenna gain)



ANTENNA RADIATION PATTERNS

FAP-U431F

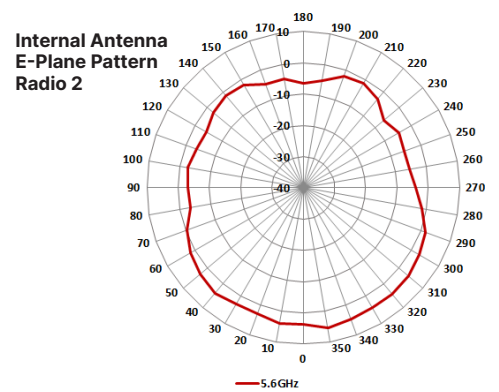
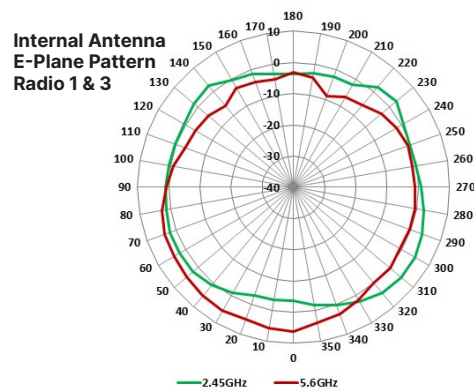
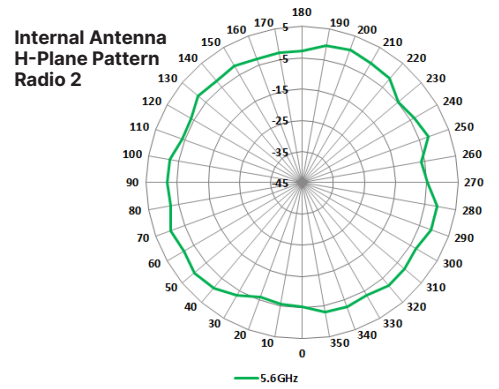
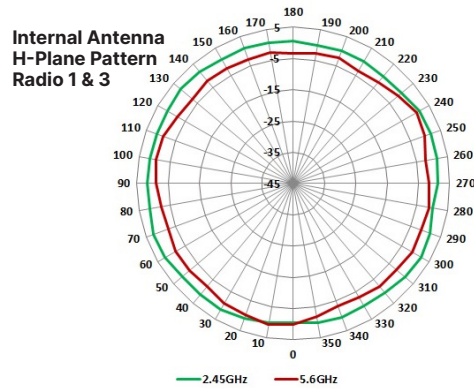

FAP-U433F

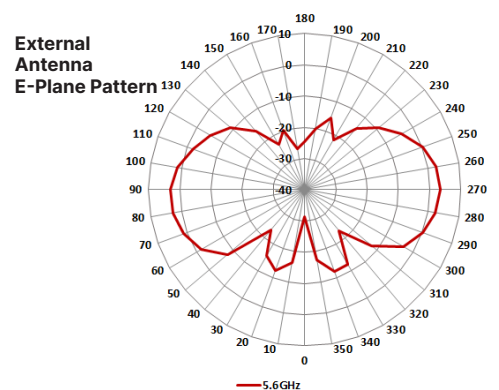
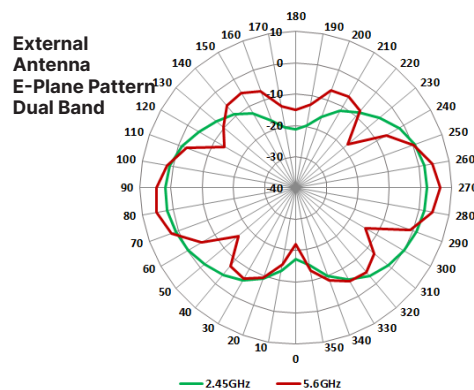
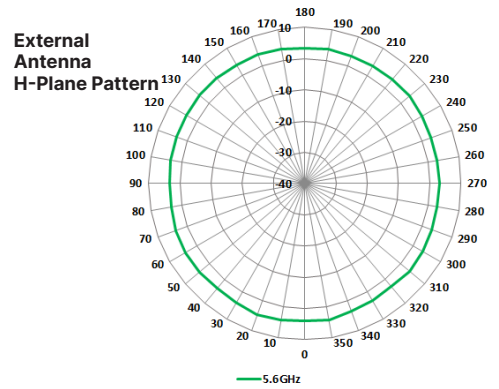
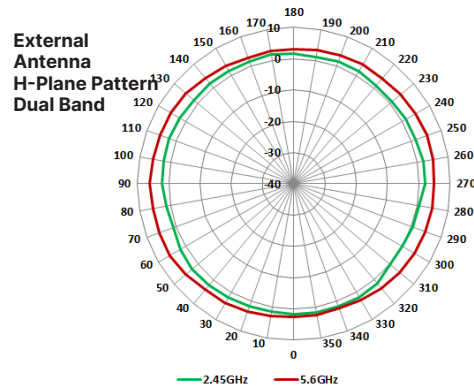
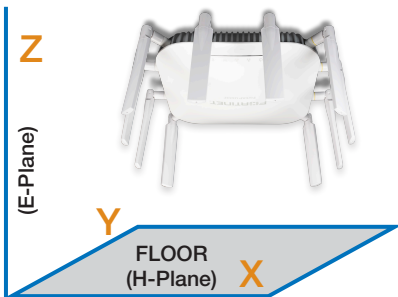

HIGHLIGHTS

FortiAP U432F

This enterprise class 802.11ax ruggedized indoor/outdoor AP provides three radios. As a top-of-the-line Wi-Fi 6 access point it provides OFDMA, a 2.5 Gigabit Ethernet port, plus an additional 1 Gbps Ethernet port with PoE out. The AP can be configured for dual 5 GHz band access while still providing coverage for devices on the 2.4 GHz band, or can be configured to offer dedicated scanning. The integrated BLE radio can be used for beacons and locationing applications.



802.11ax | Tri-Radio 5 GHz + 5 GHz + 2.4 GHz or 5 GHz + 2.4 GHz + scanning | 10 Antennas



4x4 MIMO | Up to 4,804 Mbps + 4,804 Mbps + 300 Mbps

SPECIFICATIONS

FORTIAP-U432F	
Hardware	
Hardware Type	Outdoor AP
Number of Radios	3 + 1 BLE
Number of External Antennas	11
Antenna Type and Peak Gain	Dual band Dipole Omni Directional Peak Gain 5.5dBi for 2.4GHz and 7dBi for 5.0GHz
Frequency Bands (GHz)	2.400–2.4835, 5.150–5.250, 5.250–5.350, 5.470–5.725, 5.725–5.850
Radio 1 Capabilities	2.4 GHz a/b/g/n (4x4:4stream) (64 QAM) or 5.0 GHz (high band) a/b/g/n/ac/ax (4x4:4 stream) 20/40/80/160 MHz (64/256/1024 QAM)
Radio 2 Capabilities	5.0 GHz a/b/g/n/ac/ax (4x4:4 stream) 20/40/80/160 MHz (64/256/1024 QAM)
Radio 3 Capabilities	2.4/5.0 GHz dual band b/g/n/ac (2x2:2 stream) 20/40 MHz (64 QAM)
Maximum Data Rate	Radio 1: up to 4,804 Mbps Radio 2: up to 4,804 Mbps Radio 3: up to 300 Mbps
Bluetooth Low Energy Radio	Bluetooth scanning and iBeacon advertisement @ 10 dBm max TX power
Interfaces	1x 100/1000/2500 Base-T RJ45(802.2bt PoE) , 1 x 10/100/1000 Base-T RJ45 (802.3af PSE OUT), 1x RS-232 RJ45 Serial Port
Power over Ethernet (PoE)	802.3bt PoE default (ships with Passive PoE injector) <ul style="list-style-type: none"> Powered by 802.3at PoE - Operate in 4x4 mode with reduced Tx power Radio1/R2 17dBm This product only supports PSE functionality when it is powered by PoE injector that ships with the product.
Simultaneous SSIDs	Up to 16 (14 if background scanning enabled)
EAP Type(s)	EAP-TLS, EAP-TTLS/MSCHAPv2, PEAPv0/EAP-MSCHAPv2, PEAPv1/EAP-GTC, EAP-SIM, EAP-AKA, EAP-FAST
User/Device Authentication	WPA™, WPA2™, and WPA3™ with 802.1x or Preshared key, WEP, Web Captive Portal, MAC blocklist and allowlist
Maximum Tx Power (Conducted)	Radio 1: 2.4 GHz: 29 dBm / 794 mW (4 chains combined)* 5.0 GHz: 28 dBm / 630 mW (4 chains combined)* Radio 2: 5.0 GHz: 26 dBm / 400 mW (2 chains combined)* Radio 3: 2.4 GHz: 26 dBm / 400 mW (2 chains combined) 5.0 GHz: 24 dBm / 251 mW (2 chains combined)*
Kensington Lock	No
IEEE Standards	802.11a, 802.11b, 802.11d, 802.11e, 802.11g, 802.11h, 802.11i, 802.11j, 802.11k, 802.11n, 802.11r, 802.11v, 802.11w, 802.11ac, 802.1Q, 802.1X, 802.3ad, 802.3af, 802.3at, 802.3az, 802.11ax, 802.3bz
SSID Types Supported	Local-Bridge, Mesh, & Tunnel
Per Radio Client Capacity	Up to 512 per Radio1 and Radio2
Cellular Co-existence**	Yes

* Frequency selection and power may be restricted to abide by regional regulatory compliance laws.

** Additional filtration added to reduce interference in 2.4GHz band from nearby cellular equipment.



SPECIFICATIONS

FORTIAP-U432F	
LED Off Mode	No
Advanced 802.11 Features	Yes
OFDMA	Yes (UL and DL)
2.4 GHz OFDMA	Yes
Spatial Reuse (BSS Coloring)	Yes
UL-MU-MIMO	Yes
DL-MU-MIMO	Yes
Enhanced Target Wake Time (TWT)	Yes
ZeroWait DFS / Agile DFS	Yes
Wireless Monitoring Capabilities	
Rogue Scan Radio Modes	Background, Dedicated
WIPS / WIDS Radio Modes	Background, Dedicated (recommended)
Packet Sniffer Mode	Yes
Spectrum Analyzer	Yes
Dimensions	
Length x Width x Height	8.23 × 8.23 × 2.38 inches (209 × 209 × 60.5 mm)
Weight	0 lb 8 oz (0.232 kg)
Package (shipping) Weight	12 lb 9 oz (5.7 kg)
Mounting Options	Wall and Pole
Included Accessories	1-3. Wall/ Pole/ Sector Ant. bracket 4. POE adapter 5. Power cable - PIN060 6. Grounding cable 7. Mounting Kit (Pole straps; mounting bolts, screws; grounding screws) 8. External Ant.(2.4GHz; 5GHz; 2.4/5GHz)
Environment	
Power Supply	802.3bt (ships with passive PoE injector with build in reset switch)
PSE Functionality	Yes (while powered by PoE injector shipped with product)
Power Consumption (Maximum)	32W max (without PSE) & 45W max (with PSE 12.99W)
Humidity	10–90% Non-Condensing
Operating / Storage Temperature	-22–140°F (-40 - 60°C) / -40–176°F (-40–80°C)
Directives	Low Voltage Directive • RoHS
UL2043 Plenum Material	No
Mean Time Between Failures	>10 Years
IP Rating	IP67
Surge Protection Built In	Yes
Hit-less PoE Failover	N/A
Certifications	
Wi-Fi Alliance Certified	No
DFS	CE
Warranty	
Limited Lifetime Warranty	Yes



FAP-U432F RF RX/TX PERFORMANCE TABLE

FORTIAP U432F				
	2.4 GHz		5 GHz	
	Tx Power (dBm)	Rx Sensitivity (dBm)	Tx Power (dBm)	Rx Sensitivity (dBm)
802.11 b				
1 Mbps	22	-93	—	—
11 Mbps	21	-93	—	—
802.11 a/g				
6 Mbps	21	-93	20	-91
54 Mbps	19	-75	17	-74
802.11 n HT20				
MCS0	21	-91	20	-91
MCS7	19	-71	16	-72
802.11 n HT40				
MCS0	20	-89	19	-88
MCS7	19	-69	16	-69
802.11 ac/ax VHT20				
MCS0	21	-91	19	-91
MCS8	18	-68	18	-69
802.11 ac/ax VHT40				
MCS0	20	-89	19	-88
MCS9	17	-66	16	-64
MCA 10 (QAM 1024)			15	-62
MCA 11 (QAM 1024)			15	-62
802.11 ac/ax VHT80				
MCS0			19	-85
MCS9			15	-61
MCA 10 (QAM 1024)			14	-60
MCA 11 (QAM 1024)			14	-60
802.11 ac/ax VHT160				
MCS0			17	-83
MCS9			13	-59
MCA 10 (QAM 1024)			13	-58
MCA 11 (QAM 1024)			13	-58



FAP-U432F POLE/WALL MOUNTING POSITION

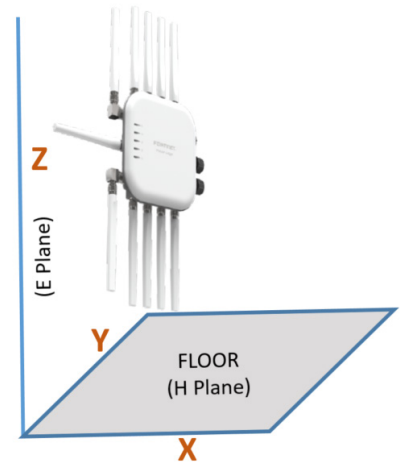

FAP-U432F ANTENNA RADIATION PATTERNS

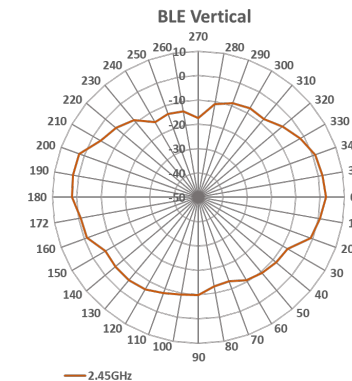
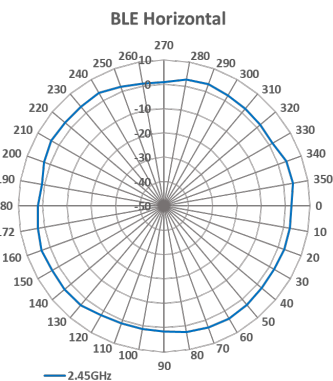
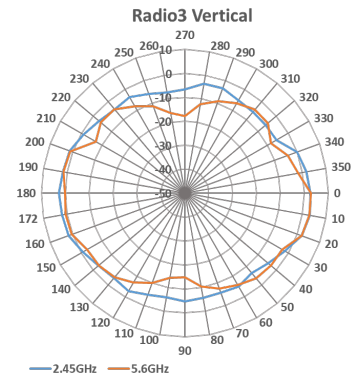
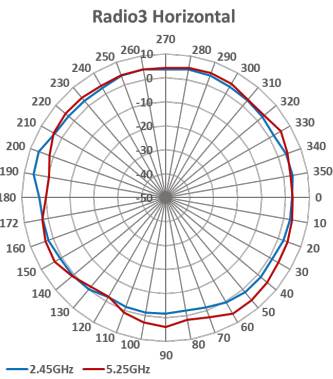
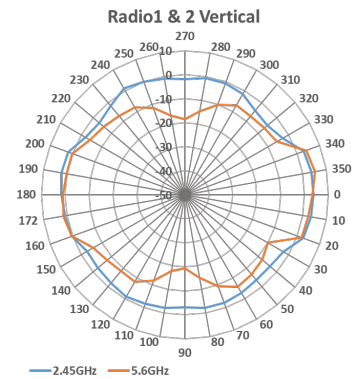
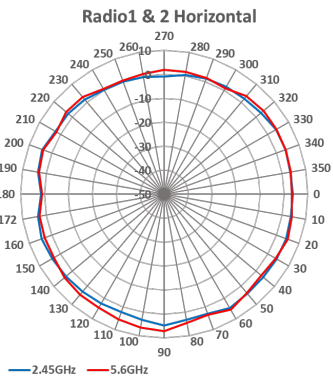

HIGHLIGHTS

FortiAP U231F

This enterprise class Wi-Fi 6 (802.11ax) indoor AP provides three radios as well as features such as OFDMA and dual 1 Gbps Ethernet ports for PoE diversity. The APs can be configured for dual 5 GHz band access while still providing coverage for devices on the 2.4 GHz band, or can be configured to offer dedicated scanning. The integrated BLE radio can be used for beacons and locationing applications.



 **802.11ax | Tri-Radio 5 GHz + 5 GHz + 2.4 GHz or 5 GHz + 2.4 GHz + scanning | 5 Antennas**

 **2x2 MIMO | Up to 1,201 Mbps + 1,201 Mbps + 574 Mbps**

SPECIFICATIONS

FORTIAP U231F	
Hardware	
Hardware Type	Indoor AP
Number of Radios	3 + 1 BLE
Number of Antennas	4 Dual band WiFi + 2 WiFi+Dual band Scanning + 1 Single band 2.4GHz BLE/ZigBee
Antenna Type and Peak Gain	PIFA antenna Dual band: 3.97 dBi for 2.4GHz and 5.89 dBi for 5GHz Single band 5Ghz antenna 5dBi for 2.4GHz band BLE antenna 3.5dBi at 2.4GHz band
Frequency Bands (GHz)	
Radio 1 Capabilities	Band: 2.4 GHz or 5.0 GHz(High Band) a/b/g/n/ac/ax (2x2:2 stream) Channel width: 20/40/80MHz Modulation: BPSK, QPSK, 64/256/1024 QAM
Radio 2 Capabilities	5.0 GHz a/b/g/n/ac/ax (2x2:2 stream) Channel width: 20/40/80MHz Modulation: BPSK, QPSK, 64/256/1024QAM
Radio 3 Capabilities	Service: (2x2:2 stream) Band: 2.4 GHz service b/g/n/ax Channel width: 20/40MHz Modulation: BPSK, QPSK, 64/256/1024QAM Scan: dual band scan
Maximum Data Rate	Radio 1: up to 1201 Mbps Radio 2: up to 1201 Mbps Radio 3: up to 574 Mbps
Bluetooth Low Energy Radio	Bluetooth scanning and iBeacon advertisement @ 10 dBm max TX power
Interfaces	2x 10/100/1000 Base-T RJ45, 1x Type 2.0 USB, 1x RS-232 RJ45 Serial Port
Power over Ethernet (PoE)	1 x 802.3at PoE default 1 x 802.af PoE with reduce TX power and no USB function
Simultaneous SSIDs	Up to 24 (21 if background scanning enabled)
EAP Type(s)	EAP-TLS, EAP-TTLS/MSCHAPv2, PEAPv0/EAP-MSCHAPv2, PEAPv1/EAP-GTC, EAP-SIM, EAP-AKA, EAP-FAST
User/Device Authentication	WPA™, WPA2™, and WPA3™ with 802.1x or Preshared key, WEP, Web Captive Portal, MAC blacklist and allowlist
Maximum Tx Power (Conducted)	Radio 1: 2.4GHz: 23 dBm / 200 mW (2 chains combined)* 5GHz: 22 dBm / 158 mW (2 chains combined)* Radio 2: 5GHz: 22 dBm / 158 mW (2 chains combined)* Radio 3: 2.4GHz: 23 dBm / 200 mW (2 chains combined)* 5GHz: 22 dBm / 158 mW (2 chains combined)*
Kensington Lock	Yes

FORTIAP U231F	
IEEE Standards	802.11a, 802.11b, 802.11e, 802.11g, 802.11h, 802.11i, 802.11j, 802.11k, 802.11n, 802.11r, 802.11v, 802.11w, 802.11ac, 802.11ax, 802.1Q, 802.1X, 802.3ad, 802.3af, 802.3at, 802.3az, Wi-Fi 6
SSID Types Supported	Local-Bridge, Tunnel, and Mesh
Per Radio Client Capacity	Up to 512 clients per radio (all radios)
Cellular Co-existence**	Yes
Reset Button	Yes
Threat Protection Capable	Yes
LED Off Mode	Yes
Advanced 802.11 Features	
Transmit Beam Forming (TxBF)	Yes
Low-Density Parity Check (LDPC) Encoding	Yes
Maximum Likelihood Demodulation (MLD)	Yes
Maximum Ratio Combining (MRC)	Yes
A-MPDU and A-MSDU Packet Aggregation	Yes
OFDMA	Yes
2.4 GHz OFDMA	Yes
Spatial Reuse (BSS Coloring)	Yes
HE-MU-MIMO	Yes
UL MU-MIMO 802.11ax mode	Yes
UL MU-MIMO 802.11ac mode	No
DL-MU-MIMO	Yes
Enhanced Target Wake Time (TWT)	Yes
ZeroWait DFS /Agile DFS	Yes
Wireless Monitoring Capabilities	
Rogue Scan radio modes	Background, Dedicated
WIPS / WIDS radio modes	Background, Dedicated (recommended)
Packet Sniffer Mode	Yes
Spectrum Analyzer	Yes
Dimensions	
Length x Width x Height	6.5 x 6.5 x 2.05 inches (165 x 165 x 52 mm)
Weight	1.5 lbs (0.68 kg)
Package (shipping) Weight	2.6 lbs (1.185 kg)
Mounting Options	Ceiling, T-Rail, and Wall
Included Accessories	Standard Mount kit for Ceiling, T-Rail and Wall



SPECIFICATIONS

FORTIAP U231F	
Environment	
Power Supply	GPI-130 or SP-FAP250-PA-10
Power Consumption (Maximum)	18.5W
Humidity	5 - 90% non condensing
Operating / Storage Temperature	32-122°F (0 - 50°C) / -22-158°F (-30-70°C)
Directives	Low Voltage Directive • RoHS
UL2043 Plenum Material	Yes
Mean Time Between Failures	> 10 Years
IP Rating	N/A
Surge Protection Built In	--
Hit-less PoE Failover	N/A
Certifications	
WiFi Alliance Certified	No
DFS	FCC, IC, CE, Japan, Taiwan, Korea
Warranty	
Limited Lifetime Warranty	Yes

* Frequency selection and power may be restricted to abide by regional regulatory compliance laws.

** Additional filtration added to reduce interference in 2.4 GHz band from nearby cellular equipment.



FAP-U231F RX/TX PERFORMANCE TABLE

FORTIAP U231F						
	Radio 1		Radio 2		Radio 3	
	Max Tx Power per transmit chain (dBm)	Rx Sensitivity per receiver chain (dBm)	Max Tx Power per transmit chain (dBm)	Rx Sensitivity per receiver chain (dBm)	Max Tx Power per transmit chain (dBm)	Rx Sensitivity per receiver chain (dBm)
2.4 GHz, 802.11b						
1 Mbps	20	-98	—	—	20	-96
11 Mbps	20	-89	—	—	20	-87
2.4 GHz, 802.11g						
6 Mbps	20	-94	—	—	20	-92
54 Mbps	19	-75	—	—	19	-73
2.4 GHz, 802.11n HT20						
MCS0	20	-93	—	—	20	-91
MCS7	18	-75	—	—	18	-72
2.4 GHz, 802.11n HT40						
MCS0	19	-91	—	—	19	-90
MCS7	18	-69	—	—	18	-71
2.4 GHz, 802.11ax HE20						
MCS0	20	93	—	—	20	-88
MCS11	19	-71	—	—	19	-69
2.4 GHz, 802.11ax HE40						
MCS0	19	-90	—	—	19	-86
MCS11	18	-65	—	—	18	-66
5.0 GHz, 802.11a						
6 Mbps	21	-92	20	-92	21	-92
54 Mbps	20	-75	19	-75	20	-75
5.0 GHz, 802.11n HT20						
MCS0	20	-91	20	-92	20	-91
MCS7	18	-74	18	-74	18	-74
5.0 GHz, 802.11n HT40						
MCS0	20	-90	20	-89	20	-90
MCS7	18	-72	18	-71	18	-72
5.0 GHz, 802.11ac VHT20						
MCS0	20	-92	20	-92	20	-92
MCS9	19	-70	19	-70	19	-70
5.0 GHz, 802.11ac VHT40						
MCS0	20	-89	20	-90	20	-89
MCS9	18	-66	18	-65	18	-66
5.0 GHz, 802.11ac VHT80						
MCS0	19	-87	19	-86	19	-87
MCS9	18	-62	18	-61	18	-62
5.0 GHz, 802.11ax HE20						
MCS0	20	-93	20	-93	20	-93
MCS11	18	-66	18	-62	18	-66
5.0GHz, 802.11ax HE40						
MCS0	20	-87	20	-90	20	-87
MCS11	18	-61	18	-60	18	-61
5.0 GHz, 802.11ax HE80						
MCS0	19	-94	19	-89	19	-94
MCS11	17	-58	17	-58	17	-58

Maximum capability of the hardware provided (excluding antenna gain)



ANTENNA RADIATION PATTERNS

FAP-U231F



**Internal Antenna
H-Plane Pattern
Radio 1 & 3**

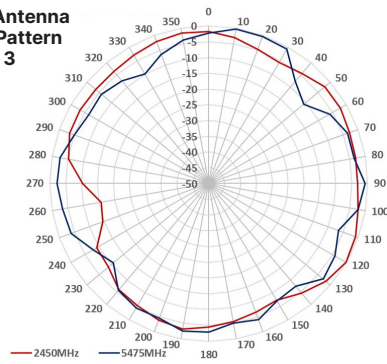

**Internal Antenna
H-Plane Pattern
Radio 2**

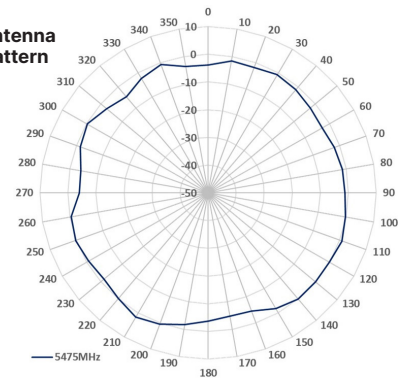

**Internal Antenna
E-Plane Pattern
Radio 1 & 3**

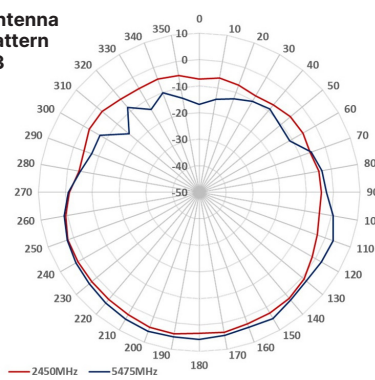

**Internal Antenna
E-Plane Pattern
Radio 2**

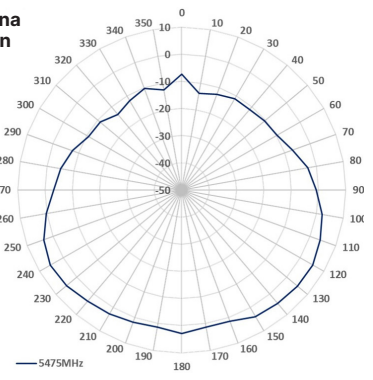

HIGHLIGHTS

FortiAP U234F

This enterprise class Wi-Fi 6 ruggedized indoor/outdoor AP provides three radios with internal antennas as well as features such as OFDMA and dual 1 Gbps Ethernet ports. The AP can be configured for dual 5 GHz band access while still providing coverage for devices on the 2.4 GHz band, or can be configured to offer dedicated scanning. The integrated BLE radio can be used for beacons and locationing applications.



 **802.11ax | Tri-Radio 5 GHz + 5 GHz + 2.4 GHz or 5 GHz + 2.4 GHz + scanning | 5 Antennas**

 **2x2 MIMO | Up to 1,201 Mbps + 1,201 Mbps + 574 Mbps**

SPECIFICATIONS

FORTIAP U234F	
Hardware	
Hardware Type	Outdoor AP
Number of Radios	3 + 1 BLE
Number of Antennas	2 WiFi 2.4GHz band + 4 WiFi 5.0GHz band + 2 WiFi+Dual band Scanning + 1 Single band 2.4GHz BLE/ZigBe
Antenna Type and Peak Gain	Directional patch Antenna
Frequency Bands (GHz)	2.400–2.4835, 5.150–5.250, 5.250–5.350, 5.470–5.725, 5.725–5.850
Radio 1 Capabilities	2.4 GHz a/b/g/n (2x2:2stream) (64 QAM) or 5.0 GHz (high band) a/b/g/n/ac/ax (2x2:2 stream) 20/40/80/160 MHz (64/256/1024 QAM)
Radio 2 Capabilities	5.0 GHz a/n/ac/ax (2x2:2 stream) 20/40/80/160 MHz (64/256/1024 QAM)
Radio 3 Capabilities	2.4/5.0 GHz dual band b/g/n/ac (2x2:2 stream) 20/40 MHz (64 QAM)
Maximum Data Rate	Radio 1: up to 2,402 Mbps Radio 2: up to 2,402 Mbps Radio 3: up to 300 Mbps
Bluetooth Low Energy Radio	Bluetooth scanning and iBeacon advertisement @ 10 dBm max TX power
Interfaces	1x 100/1000/2500 Base-T RJ45(802.2bt/at PoE) 1x 10/100/1000 Base-T RJ45 (802.3af PoE PSE), 1x RS-232 RJ45 Serial Port
Power over Ethernet (PoE)	802.3bt PoE ships with PoE injector (reset functionality)
Simultaneous SSIDs	Up to 16 (14 if background scanning enabled)
EAP Type(s)	EAP-TLS, EAP-TTLS/MSCHAPv2, PEAPv0/EAP-MSCHAPv2, PEAPv1/EAP-GTC, EAP-SIM, EAP-AKA, EAP-FAST
User/Device Authentication	WPA™, WPA2™, and WPA3™ with 802.1x or Preshared key, WEP, Web Captive Portal, MAC blacklist and allowlist
Maximum Tx Power (Conducted)	Radio 1: 2.4GHz: 25 dBm / 316 mW (2 chains combined)* 5GHz: 25 dBm / 316 mW (2 chains combined)* Radio 2: 5GHz: 25 dBm / 316 mW (2 chains combined)* Radio 3: 2.4GHz: 27 dBm / 501 mW (2 chains combined)* 5GHz: 25 dBm / 316 mW (2 chains combined)*

FORTIAP U234F	
Kensington Lock	No
IEEE Standards	802.11a, 802.11b, 802.11d, 802.11e, 802.11g, 802.11h, 802.11i, 802.11j, 802.11k, 802.11n, 802.11r, 802.11v, 802.11w, 802.11ac, 802.1Q, 802.1X, 802.3ad, 802.3af, 802.3at, 802.3az, 802.11ax, 802.3bz
SSID Types Supported	Local-Bridge, Mesh, & Tunnel
Per Radio Client Capacity	Up to 512 clients per Radio1 and Radio2
Cellular Co-existence**	Yes
LED Off Mode	No
Advanced 802.11 Features	Yes
OFDMA	Yes (UL and DL)
Spatial Reuse (BSS Coloring)	Yes
UL MU-MIMO	Yes
DL-MU-MIMO	Yes
Enhanced Target Wake Time (TWT)	Yes
ZeroWait DFS /Agile DFS	Yes
Wireless Monitoring Capabilities	
Rogue Scan radio modes	Background and Dedicated
WIPS / WIDS radio modes	Background and Dedicated (recommended)
Packet Sniffer Mode	Yes
Spectrum Analyzer	Yes
Dimensions	
Length x Width x Height	12.45 x 8.59 x 1.66 inches (316.18 x 218.16 x 42.21 mm)
Weight	2.66 lbs (1.207 kg)
Package (shipping) Weight	5.86 lbs (3.6 kg)
Mounting Options	Wall/ Pole
Included Accessories	1-2. Wall/ Pole bracket 3. POE adapter - PIN060-54PR 4. Power cable 5. Grounding cable 6. Mounting Kit (Pole straps; mounting bolts, screws; grounding screws)



SPECIFICATIONS

FORTIAP U234F	
Environment	
Power Supply	802.3bt/at (ships with passive PoE injector with build in reset switch)
Power Consumption (Maximum)	21 Watts
Humidity	10 - 90% non condensing
Operating / Storage Temperature	-22-140°F (-40 - 60°C) / -40-176°F (-40-80°C)
Directives	Low Voltage Directive • RoHS
UL2043 Plenum Material	No
Mean Time Between Failures	> 10 Years
IP Rating	IP67
Surge Protection Built In	Yes
Hit-less PoE Failover	N/A
Certifications	
WiFi Alliance Certified	No
DFS	None
Warranty	
Limited Lifetime Warranty	Yes

* Frequency selection and power may be restricted to abide by regional regulatory compliance laws.

** Additional filtration added to reduce interference in 2.4 GHz band from nearby cellular equipment.



FAP-U234F RF RX/TX PERFORMANCE TABLE

FORTIAP U234F				
	2.4 GHz		5 GHz	
	Tx Power (dBm)	Rx Sensitivity (dBm)	Tx Power (dBm)	Rx Sensitivity (dBm)
802.11 b				
1 Mbps	23	-98	—	—
11 Mbps	23	-90	—	—
802.11 a/g				
6 Mbps	23	-93	22	-91
54 Mbps	19	-75	17	-74
802.11 n HT20				
MCS0	23	-91	22	-91
MCS7	19	-71	16	-72
802.11 n HT40				
MCS0	23	-89	22	-88
MCS7	19	-69	16	-69
802.11 ac/ax VHT20				
MCS0	23	-91	22	-91
MCS8	18	-68	18	-69
802.11 ac/ax VHT40				
MCS0	23	-89	22	-88
MCS9	17	-66	16	-64
MCA 10 (QAM 1024)			15	-62
MCA 11 (QAM 1024)			15	-62
802.11 ac/ax VHT80				
MCS0			22	-85
MCS9			15	-61
MCA 10 (QAM 1024)			14	-60
MCA 11 (QAM 1024)			14	-60
802.11 ac/ax VHT160				
MCS0			1722	-83
MCS9			13	-59
MCA 10 (QAM 1024)			13	-58
MCA 11 (QAM 1024)			13	-58



FAP-U234F POLE/WALL MOUNTING POSITION

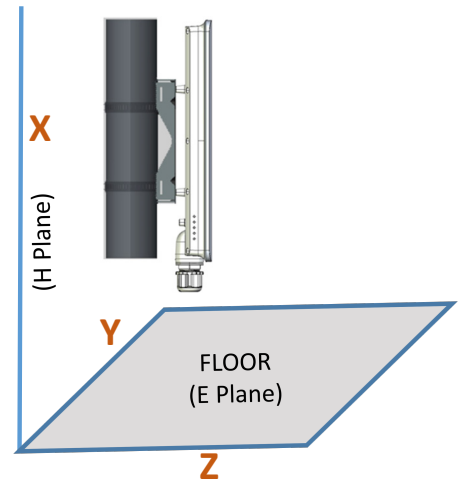
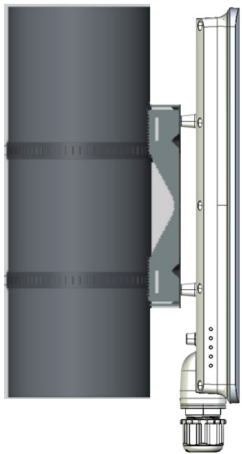

FAP-U234F ANTENNA RADIATION PATTERNS

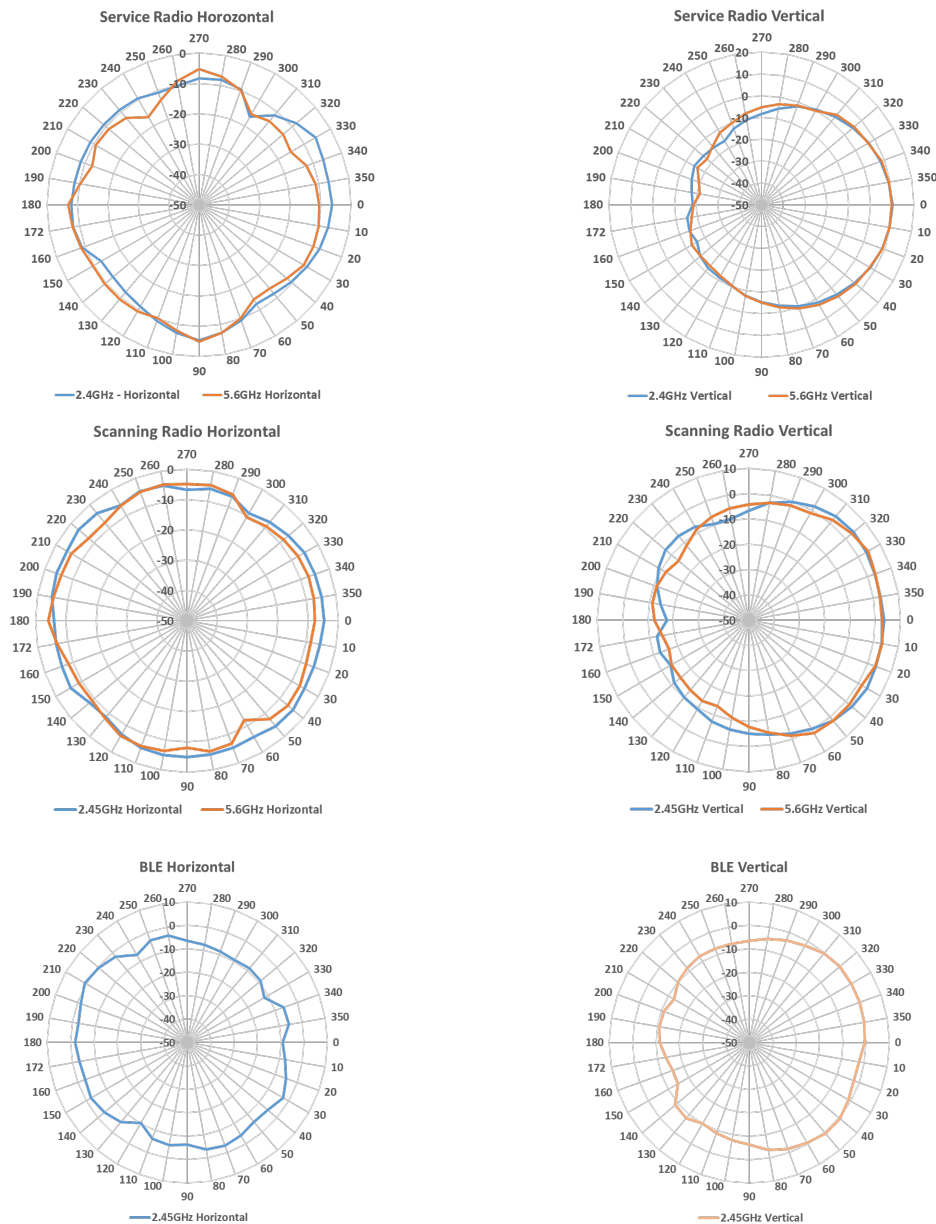

HIGHLIGHTS

FortiAP U421EV and U423EV

The FortiAP U421EV and U423EV access points support the latest 802.11ac Wave 2 standard, with a maximum data rate of up to 3.4 Gbps. Additional features include 802.11ac explicit transmit beamforming (TxBF), MU-MIMO, and more.

Note: This AP is not UTP capable.



 802.11ac Wave 2 | Dual Radio 2.4 & 5 GHz | 8 Internal/External Antennas

 4x4 MU-MIMO | Up to 600 Mbps + 3,466 Mbps

SPECIFICATIONS

	FORTIAP U421EV	FORTIAP U423EV
Hardware		
Hardware Type	Indoor AP	Indoor AP
Number of Radios	2 + 1 BLE	2 + 1 BLE
Number of Antennas	8 Internal + 1 BLE Internal	8 External (RP-SMA) + 1 BLE Internal
Antenna Type and Peak Gain	Patch: 4 dBi for 2.4 GHz, 5 dBi for 5 GHz	Dipole: 3 dBi for 2.4 GHz, 3 dBi for 5 GHz
Frequency Bands (GHz)	2.400–2.4835, 5.150–5.250, 5.250–5.350, 5.470–5.725, 5.725–5.850	2.400–2.4835, 5.150–5.250, 5.250–5.350, 5.470–5.725, 5.725–5.850
Radio 1 Capabilities	2.4 GHz b/g/n (4x4:4 stream) 20/40 MHz (64 QAM)	2.4 GHz b/g/n (4x4:4 stream) 20/40 MHz (64 QAM)
Radio 2 Capabilities	5 GHz a/n/ac (4x4:4 stream) 20/40/80/160 MHz (256 QAM)	5 GHz a/n/ac (4x4:4 stream) 20/40/80/160 MHz (256 QAM)
Maximum Data Rate	Radio 1: up to 600 Mbps Radio 2: up to 3,466 Mbps	Radio 1: up to 600 Mbps Radio 2: up to 3,466 Mbps
Bluetooth Low Energy Radio	Bluetooth scanning and iBeacon advertisement @ 4 dBm max TX power	Bluetooth scanning and iBeacon advertisement @ 4 dBm max TX power
Interfaces	2x 10/100/1000 Base-T RJ45, 1x Type A USB, 1x RS-232 RJ45 Serial Port	2x 10/100/1000 Base-T RJ45, 1x Type A USB, 1x RS-232 RJ45 Serial Port
Power over Ethernet (PoE)	Dual redundant PoE power ports with support for IEEE 802.3at (2x2 operation at 17 dBm TX Power and USB disabled with 802.3af)	Dual redundant PoE power ports with support for IEEE 802.3at (2x2 operation at 17 dBm TX Power and USB disabled with 802.3af)
Simultaneous SSIDs	Up to 16 (14 if background scanning enabled)	Up to 16 (14 if background scanning enabled)
EAP Type(s)	EAP-TLS, EAP-TTLS/MSCHAPv2, PEAPv0/EAP-MSCHAPv2, PEAPv1/EAP-GTC EAP-SIM, EAP-AKA, EAP-FAST	EAP-TLS, EAP-TTLS/MSCHAPv2, PEAPv0/EAP-MSCHAPv2, PEAPv1/EAP-GTC EAP-SIM, EAP-AKA, EAP-FAST
User/Device Authentication	WPA™, WPA2™, and WPA3™ with 802.1x or Preshared key, WEP, Web Captive Portal, MAC blocklist and allowlist	WPA™, WPA2™, and WPA3™ with 802.1x or Preshared key, WEP, Web Captive Portal, MAC blocklist and allowlist
Maximum Tx Power (Conducted)	2.4 GHz: 28 dBm / 631 mW (4 chains combined)* 5 GHz: 26 dBm / 398mW (4 chains combined)*	2.4 GHz: 28 dBm / 631 mW (4 chains combined)* 5 GHz: 26 dBm / 398mW (4 chains combined)*
Kensington Lock	Yes	Yes
IEEE Standards	802.11a, 802.11b, 802.11d, 802.11e, 802.11g, 802.11h, 802.11i, 802.11j, 802.11k, 802.11n, 802.11v, 802.11w, 802.11ac, 802.1Q, 802.1X, 802.3ad, 802.3af, 802.3at, 802.3az	802.11a, 802.11b, 802.11d, 802.11e, 802.11g, 802.11h, 802.11i, 802.11j, 802.11k, 802.11n, 802.11v, 802.11w, 802.11ac, 802.1Q, 802.1X, 802.3ad, 802.3af, 802.3at, 802.3az
SSID Types Supported	Local-Bridge, Tunnel & Mesh	Local-Bridge, Tunnel & Mesh
Per Radio Client Capacity	Up to 256	Up to 256
Cellular Co-existence**	Yes	Yes
Reset Button	Yes	Yes
LED Off Mode	Yes	Yes

* Frequency selection and power may be restricted to abide by regional regulatory compliance laws.

** Additional filtration added to reduce interference in 2.4GHz band from nearby cellular equipment.



SPECIFICATIONS

	FORTIAP U421EV	FORTIAP U423EV
Advanced 802.11 Features		
802.11ac MU-MIMO Wave 2	Yes	Yes
Transmit Beam Forming (TxBF)	Yes	Yes
Low-Density Parity Check (LDPC) Encoding	Yes	Yes
Maximum Likelihood Demodulation (MLD)	Yes	Yes
Maximum Ratio Combining (MRC)	Yes	Yes
A-MPDU and A-MSDU Packet Aggregation	Yes	Yes
MIMO Power Save	Yes	Yes
Short Guard Interval	Yes	Yes
Wireless Monitoring Capabilities		
Rogue Scan Radio Modes	Background, Dedicated	Background, Dedicated
WIPS / WIDS Radio Modes	Background, Dedicated (recommended)	Background, Dedicated (recommended)
Packet Sniffer Mode	Yes	Yes
Spectrum Analyzer	Yes	Yes
Dimensions		
Length x Width x Height	8.46 x 8.46 x 2.2 inches (215 x 215 x 56 mm)	8.46 x 8.46 x 2.2 inches (215 x 215 x 56 mm)
Weight	3.31 lbs (1.5 kg)	3.4 lbs (1.53 kg)
Package (shipping) Weight	5.09 lbs (2.31 kg)	5.36 lbs (2.43 kg)
Mounting Options	Ceiling, T-Rail and Wall	Ceiling, T-Rail and Wall
Included Accessories	Mount kits for Ceiling, T-Rail and Wall	Mount kits for Ceiling, T-Rail and Wall, 8 dipole antennas
Environment		
Power Supply	SP-FAP400-PA-XX, GPI-115, or GPI-130	SP-FAP400-PA-XX, GPI-115, or GPI-130
Power Consumption (Maximum)	24.5 W max power draw in 802.3at mode and 12.5 W max power draw when in 802.3af power mode (operates in at reduced power and spatial streams)	24.5 W max power draw in 802.3at mode and 12.5 W max power draw when in 802.3af power mode (operates in at reduced power and spatial streams)
Humidity	5–90% non-condensing	5–90% non-condensing
Operating / Storage Temperature	-4–122°F (-20–50°C) / -40–158°F (-40–70°C)	-4–122°F (-20–50°C) / -40–158°F (-40–70°C)
Directives	Low Voltage Directive • RoHS	Low Voltage Directive • RoHS
UL2043 Plenum Material	Yes	Yes
Mean Time Between Failures	>30 Years	>30 Years
IP Rating	—	—
Surge Protection Built In	—	—
Hit-less PoE Failover	Yes	Yes
Certifications		
Wi-Fi Alliance Certified	Yes	Yes
DFS	FCC, IC, CE, Japan, Taiwan, Korea	FCC, IC, CE, Japan, Taiwan, Korea
Warranty		
Limited Lifetime Warranty	Yes	Yes



FAP-U421EV / FAP-U423EV RF RX/TX PERFORMANCE TABLE

FORTIAP U421EV AND U423EV				
802.11 a/g	Radio 1 2.4 GHz		Radio 2 5 GHz	
	Max Tx Power per transmit chain (dBm)	Rx Sensitivity per receiver chain (dBm)	Max Tx Power per transmit chain (dBm)	Rx Sensitivity per receiver chain (dBm)
6 Mbps	22	-94	20	-91
9 Mbps	22	-92	20	-89
12 Mbps	22	-89	20	-86
18 Mbps	22	-88	20	-85
24 Mbps	22	-83	20	-80
36 Mbps	22	-78	19	-75
48 Mbps	22	-77	19	-74
54 Mbps	19	-76	18	-73
802.11 HT20	Tx Power (dBm)	Rx Sensitivity (dBm)	Tx Power (dBm)	Rx Sensitivity (dBm)
MSC 0/8/16 (BPSK)	22	-91	20	-89
MSC 1/9/17 (QPSK)	21	-89	19	-87
MSC 2/10/18 (QPSK)	20	-86	19	-84
MSC 3/11/19 (16-QAM)	19	-85	18	-83
MSC 4/12/20 (16-QAM)	19	-80	17	-78
MSC 5/13/21 (64-QAM)	18	-75	17	-73
MSC 6/14/22 (64-QAM)	18	-74	17	-72
MSC 7/15/23 (64-QAM)	18	-73	17	-71
802.11 HT40	Tx Power (dBm)	Rx Sensitivity (dBm)	Tx Power (dBm)	Rx Sensitivity (dBm)
MSC 0/8/16 (BPSK)	21	-89	20	-86
MSC 1/9/17 (QPSK)	20	-87	19	-84
MSC 2/10/18 (QPSK)	20	-84	19	-81
MSC 3/11/19 (16-QAM)	19	-83	18	-80
MSC 4/12/20 (16-QAM)	19	-78	18	-75
MSC 5/13/21 (64-QAM)	18	-73	17	-70
MSC 6/14/22 (64-QAM)	18	-72	17	-69
MSC 7/15/23 (64-QAM)	18	-71	17	-68
MSC 8/16/24 (256-QAM)	-	-	14	-65
MSC 9/17/25 (256-QAM)	-	-	14	-63
802.11 HT80	Tx Power (dBm)	Rx Sensitivity (dBm)	Tx Power (dBm)	Rx Sensitivity (dBm)
MSC 0 (BPSK)	-	-	18	-83
MSC 1 (QPSK)	-	-	17	-80
MSC 2 (QPSK)	-	-	17	-78
MSC 3 (16-QAM)	-	-	16	-75
MSC 4 (16-QAM)	-	-	16	-73
MSC 5 (64-QAM)	-	-	15	-72
MSC 6 (64-QAM)	-	-	15	-70
MSC 7 (64-QAM)	-	-	15	-69
MSC 8 (256-QAM)	-	-	15	-65
MSC 9 (256-QAM)	-	-	15	-59

Maximum capability of the Hardware provided (Excluding antenna gain)



ANTENNA RADIATION PATTERNS

FAP-U421EV

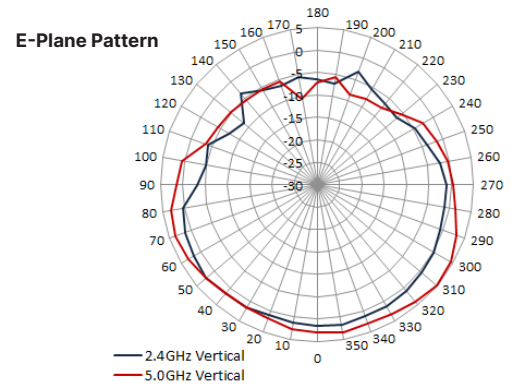
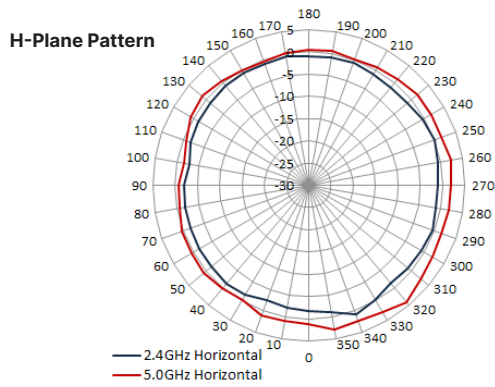
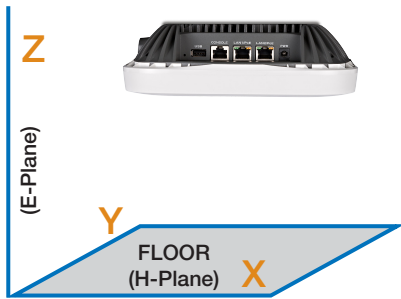

FAP-U423EV

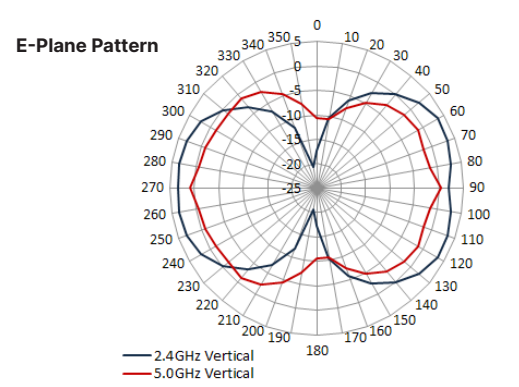
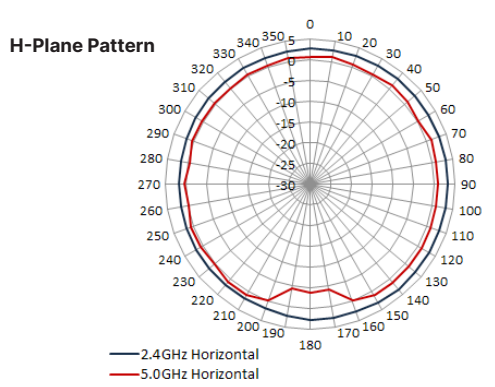
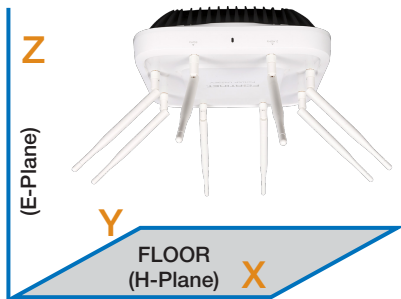

PERFORMANCE MATRIX

FAP-U421EV AND FAP-U423EV 802.11AC PERFORMANCE — DATA RATES (MBPS)									
Descriptor	Data Streams	VHT20		VHT40		VHT80		VH160	
		Normal GI	Short GI	Normal GI	Short GI	Normal GI	Short GI	Normal GI	Short GI
MCS 0	1	6.5	7.2	13.5	15	29.3	32.5	58.6	65
MCS 1	1	13	14.4	27	30	58.5	65	117	130
MCS 2	1	19.5	21.7	40.5	45	87.8	97.5	175.6	195
MCS 3	1	26	28.9	54	60	117	130	234	260
MCS 4	1	39	43.3	81	90	175.5	195	351	390
MCS 5	1	52	57.8	108	120	234	260	468	520
MCS 6	1	58.5	65	121.5	135	263.3	292.5	526.6	585
MCS 7	1	65	72.2	135	150	292.5	325	585	650
MCS 8	1	78	86.7	162	180	351	390	702	780
MCS 9	1	NA	NA	180	200	390	433.3	780	866.6
MCS 0	2	13	14.4	27	30	58.5	65	117	130
MCS 1	2	26	28.9	54	60	117	130	234	260
MCS 2	2	39	43.3	81	90	175.5	195	351	390
MCS 3	2	52	57.8	108	120	234	260	468	520
MCS 4	2	78	86.7	162	180	351	390	702	780
MCS 5	2	104	115.6	216	240	468	520	936	1040
MCS 6	2	117	130	243	270	526.5	585	1053	1170
MCS 7	2	130	144.4	270	300	585	650	1170	1300
MCS 8	2	156	173.3	324	360	702	780	1404	1560
MCS 9	2	NA	NA	360	400	780	866.7	1560	1733.4
MCS 0	3	19.5	21.7	40.5	45	87.8	97.5	175.6	195
MCS 1	3	39	43.3	81	90	175.5	195	351	390
MCS 2	3	58.5	65	121.5	135	263.3	292.5	526.6	585
MCS 3	3	78	86.7	162	180	351	390	702	780
MCS 4	3	117	130	243	270	526.5	585	1053	1170
MCS 5	3	156	173.3	324	360	702	780	1404	1560
MCS 6	3	175.5	195	364.5	405	NA	NA	NA	NA
MCS 7	3	195	216.7	405	450	877.5	975	1755	1950
MCS 8	3	234	260	486	540	1053	1170	2106	2340
MCS 9	3	260	288.9	540	600	1170	1300	N/A	N/A
MCS 0	4	26	28.9	54	60	117	130	234	260
MCS 1	4	52	57.8	108	120	234	260	468	520
MCS 2	4	78	86.7	162	180	351	390	702	780
MCS 3	4	104	115.6	216	240	468	520	936	1040
MCS 4	4	156	173.3	324	360	702	780	1404	1560
MCS 5	4	208	231.1	432	480	936	1040	1872	2080
MCS 6	4	234	260	486	540	1053	1170	2106	2340
MCS 7	4	260	288.9	540	600	1170	1300	2340	2600
MCS 8	4	312	346.7	648	720	1404	1560	2808	3120
MCS 9	4	NA	NA	720	800	1560	1733.3	3120	3466.6



HIGHLIGHTS

FortiAP U422EV

This enterprise class 802.11ac Wave 2 outdoor AP provides dual concurrent 4×4 radios in both 2.4 GHz and 5 GHz frequencies. This top-of-the-line access point provides MU-MIMO, two Gigabit Ethernet ports and supports 1xPD+1xPSE function and withstands harsh outdoor environments with certified IP67 industrial grade protection.



Note: This AP is not UTP capable.

 **802.11ac Wave 2 | Dual Radio 2.4 GHz & 5 GHz | 8 External Antennas**

 **4×4 MU-MIMO | Up to 600 Mbps + 3,466 Mbps**

SPECIFICATIONS

FORTIAP U422EV	
Hardware	
Hardware Type	Outdoor AP
Number of Radios	2 + 1 BLE
Number of Antennas	8 External (Type N) + 1 BLE Internal
Antenna Type and Peak Gain	Dipole: 5 dBi for 2.4 GHz, 7 dBi for 5 GHz
Frequency Bands (GHz)	2.400–2.4835, 5.150–5.250, 5.250–5.350, 5.470–5.725, 5.725–5.850
Radio 1 Capabilities	2.4 GHz b/g/n (4×4:4 stream) 20/40 MHz (64 QAM)
Radio 2 Capabilities	5 GHz a/n/ac (4×4:4 stream) 20/40/80/160 MHz (256 QAM)
Maximum Data Rate	Radio 1: up to 600 Mbps Radio 2: up to 3,466 Mbps
Bluetooth Low Energy Radio	Bluetooth scanning and iBeacon advertisement @ 4 dBm max TX power
Interfaces	2× 10/100/1000 Base-T RJ45, 1x RS-232 RJ45 Serial Port
Power over Ethernet (PoE)	LAN1 supports 802.3at or proprietary PoE injector. LAN2 supports 802.3af PSE Out.
Simultaneous SSIDs	Up to 16 (14 if background scanning enabled)
EAP Type(s)	EAP-TLS, EAP-TTLS/MSCHAPv2, PEAPv0/EAP-MSCHAPv2, PEAPv1/EAP-GTC EAP-SIM, EAP-AKA, EAP-FAST
User/Device Authentication	WPA™, WPA2™, and WPA3™ with 802.1x or Preshared key, WEP, Web Captive Portal, MAC blocklist and allowlist
Maximum Tx Power (Conducted)	2.4 GHz: 24 dBm / 251 mW (4 chains combined)* 5 GHz: 24 dBm / 251 mW (4 chains combined)*
Kensington Lock	No
IEEE Standards	802.11a, 802.11b, 802.11d, 802.11e, 802.11g, 802.11h, 802.11i, 802.11j, 802.11k, 802.11n, 802.11v, 802.11w, 802.11ac, 802.1Q, 802.1X, 802.3af, 802.3at, 802.3az, 802.3ad
SSID Types Supported	Local-Bridge, Tunnel & Mesh
Per Radio Client Capacity	Up to 256
Cellular Co-existence**	Yes
Reset Button	Yes
LED Off Mode	Yes
Advanced 802.11 Features	
802.11ac MU-MIMO Wave 2	Yes
Transmit Beam Forming (TxBF)	Yes
Low-Density Parity Check (LDPC) Encoding	Yes
Maximum Likelihood Demodulation (MLD)	Yes
Maximum Ratio Combining (MRC)	Yes

FORTIAP U422EV	
A-MPDU and A-MSDU Packet Aggregation	Yes
MIMO Power Save	Yes
Short Guard Interval	Yes
Wireless Monitoring Capabilities	
Rogue Scan Radio Modes	Background, Dedicated
WIPS / WIDS Radio Modes	Background, Dedicated (recommended)
Packet Sniffer Mode	Yes
Spectrum Analyzer	Yes
Dimensions	
Length x Width x Height	8.3 × 8.3 × 2.0 inches (210 × 210 × 51 mm)
Weight	4.08 lbs (1.85 kg)
Package (shipping) Weight	11.42 lbs (5.18 kg)
Mounting Options	Wall Mount or Pole Mount
Included Accessories	Mounting Kits, Grounding Cable, 4× 2.4 GHz and 4× 5 GHz dipole Antennas
Environment	
Power Supply	Proprietary PoE injector or GPI-130
Power Consumption (Maximum)	22 W
Humidity	5–90% non-condensing
Operating / Storage Temperature	-40–140°F (-40–60°C) / -40–158°F (-40–70°C)
Directives	Low Voltage Directive • RoHS
UL2043 Plenum Material	No
Mean Time Between Failures	>9.9 Years
IP Rating	IP67
Surge Protection Built In	Yes
Hit-less PoE Failover	No
Certifications	
Wi-Fi Alliance Certified	Yes
DFS	FCC, IC, CE, Japan
Warranty	
Limited Lifetime Warranty	Yes

* Frequency selection and power may be restricted to abide by regional regulatory compliance laws.
** Additional filtration added to reduce interference in 2.4 GHz band from nearby cellular equipment.



FAP-U422EV RF RX/TX PERFORMANCE TABLE

FORTIAP U422EV				
802.11 a/g	Radio 1 2.4 GHz		Radio 2 5 GHz	
	Max Tx Power per transmit chain (dBm)	Rx Sensitivity per receiver chain (dBm)	Max Tx Power per transmit chain (dBm)	Rx Sensitivity per receiver chain (dBm)
6 Mbps	18	-92	18	-91
9 Mbps	18	-90	18	-89
12 Mbps	18	-88	18	-87
18 Mbps	18	-84	18	-85
24 Mbps	18	-82	18	-82
36 Mbps	18	-78	18	-80
48 Mbps	18	-77	18	-77
54 Mbps	18	-75	15	-73
802.11 HT20	Tx Power (dBm)	Rx Sensitivity (dBm)	Tx Power (dBm)	Rx Sensitivity (dBm)
MCS 0 (BPSK)	18	-92	18	-91
MCS 1 (QPSK)	18	-89	18	-88
MCS 2 (QPSK)	18	-86	18	-86
MCS 3 (16-QAM)	18	-83	18	-83
MCS 4 (16-QAM)	18	-80	18	-79
MCS 5 (64-QAM)	18	-75	18	-75
MCS 6 (64-QAM)	17	-74	16	-74
MCS 7 (64-QAM)	17	-72	15	-71
802.11 HT40	Tx Power (dBm)	Rx Sensitivity (dBm)	Tx Power (dBm)	Rx Sensitivity (dBm)
MCS 0 (BPSK)	18	-90	18	-87
MCS 1 (QPSK)	18	-86	18	-84
MCS 2 (QPSK)	18	-84	18	-82
MCS 3 (16-QAM)	18	-80	18	-79
MCS 4 (16-QAM)	18	-77	17	-75
MCS 5 (64-QAM)	18	-73	16	-71
MCS 6 (64-QAM)	17	-71	15	-70
MCS 7 (64-QAM)	16	-70	14	-69
MCS 8 (256-QAM)	-	-	14	-64
MCS 9 (256-QAM)	-	-	13	-62
802.11 HT80	Tx Power (dBm)	Rx Sensitivity (dBm)	Tx Power (dBm)	Rx Sensitivity (dBm)
MCS 0 (BPSK)	-	-	18	-84
MCS 1 (QPSK)	-	-	18	-81
MCS 2 (QPSK)	-	-	18	-79
MCS 3 (16-QAM)	-	-	18	-76
MCS 4 (16-QAM)	-	-	17	-72
MCS 5 (64-QAM)	-	-	16	-68
MCS 6 (64-QAM)	-	-	15	-67
MCS 7 (64-QAM)	-	-	14	-66
MCS 8 (256-QAM)	-	-	13	-61
MCS 9 (256-QAM)	-	-	12	-59

Maximum capability of the hardware provided (excluding antenna gain).



ANTENNA RADIATION PATTERNS

FAP-U422EV



E-Plane Pattern

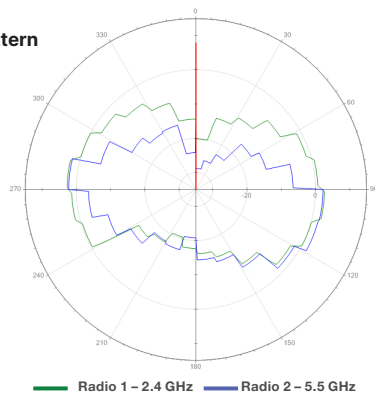

H-Plane Pattern

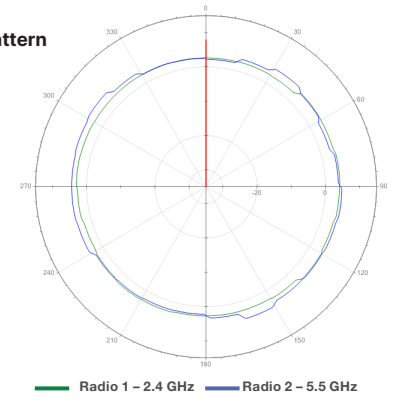

HIGHLIGHTS

FortiAP U321EV and U323EV

The FortiAP U321EV and U323EV access points support the latest 802.11ac Wave 2 standard, with a maximum data rate of up to 2.6 Gbps. Additional features include 802.11ac explicit transmit beamforming (TxBF), MU-MIMO built in BLE radio for location services and more.

Note: This AP is not UTP capable.



 802.11ac Wave 2 | Dual Radio 2.4 & 5 GHz | 6 Internal/External Antennas

 3x3 MU-MIMO | Up to 450 Mbps + 1,300 Mbps

SPECIFICATIONS

	FORTIAP U321EV	FORTIAP U323EV
Hardware		
Hardware Type	Indoor AP	Indoor AP
Number of Radios	2 + 1 BLE	2 + 1 BLE
Number of Antennas	6 Internal + 1 BLE Internal	6 External (RP-SMA) + 1 BLE Internal
Antenna Type and Peak Gain	Patch: 4.5 dBi for 2.4 GHz, 6.5 dBi for 5 GHz	Dipole: 3.5 dBi for 2.4 GHz, 5 dBi for 5 GHz
Frequency Bands (GHz)	2.400–2.4835, 5.150–5.250, 5.250–5.350, 5.470–5.725, 5.725–5.850	2.400–2.4835, 5.150–5.250, 5.250–5.350, 5.470–5.725, 5.725–5.850
Radio 1 Capabilities	2.4 GHz b/g/n (3x3:3 stream) 20/40 MHz (64 QAM)	2.4 GHz b/g/n (3x3:3 stream) 20/40 MHz (64 QAM)
Radio 2 Capabilities	5 GHz a/n/ac (3x3:3 stream) 20/40/80 MHz (256 QAM)	5 GHz a/n/ac (3x3:3 stream) 20/40/80 MHz (256 QAM)
Maximum Data Rate	Radio 1: up to 450 Mbps Radio 2: up to 1,733 Mbps	Radio 1: up to 450 Mbps Radio 2: up to 1,733 Mbps
Bluetooth Low Energy Radio	Bluetooth scanning and iBeacon advertisement @ 4 dBm max TX power	Bluetooth scanning and iBeacon advertisement @ 4 dBm max TX power
Interfaces	2x 10/100/1000 Base-T RJ45, 1x Type A USB, 1x RS-232 RJ45 Serial Port	2x 10/100/1000 Base-T RJ45, 1x Type A USB, 1x RS-232 RJ45 Serial Port
Power over Ethernet (PoE)	Dual redundant PoE power ports with support for IEEE 802.3at (20 dBm TX Power and USB disabled with 802.3af)	Dual redundant PoE power ports with support for IEEE 802.3at (20 dBm TX Power and USB disabled with 802.3af)
Simultaneous SSIDs	Up to 16 (14 if background scanning enabled)	Up to 16 (14 if background scanning enabled)
EAP Type(s)	EAP-TLS, EAP-TTLS/MSCHAPv2, PEAPv0/EAP-MSCHAPv2, PEAPv1/EAP-GTC EAP-SIM, EAP-AKA, EAP-FAST	EAP-TLS, EAP-TTLS/MSCHAPv2, PEAPv0/EAP-MSCHAPv2, PEAPv1/EAP-GTC EAP-SIM, EAP-AKA, EAP-FAST
User/Device Authentication	WPA™, WPA2™, and WPA3™ with 802.1x or Preshared key, WEP, Web Captive Portal, MAC blocklist and allowlist	WPA™, WPA2™, and WPA3™ with 802.1x or Preshared key, WEP, Web Captive Portal, MAC blocklist and allowlist
Maximum Tx Power (Conducted)	2.4 GHz: 26.7 dBm / 468 mW (3 chains combined)* 5 GHz: 24.7 dBm / 295 mW (3 chains combined)*	2.4 GHz: 26.7 dBm / 468 mW (3 chains combined)* 5 GHz: 24.7 dBm / 295 mW (3 chains combined)*
Kensington Lock	Yes	Yes
IEEE Standards	802.11a, 802.11b, 802.11d, 802.11e, 802.11g, 802.11h, 802.11i, 802.11j, 802.11k, 802.11n, 802.11v, 802.11w, 802.11ac, 802.11q, 802.1X, 802.3af, 802.3at, 802.3az, 802.3ad	802.11a, 802.11b, 802.11d, 802.11e, 802.11g, 802.11h, 802.11i, 802.11j, 802.11k, 802.11n, 802.11v, 802.11w, 802.11ac, 802.11q, 802.1X, 802.3af, 802.3at, 802.3az, 802.3ad
SSID Types Supported	Local-Bridge, Tunnel & Mesh	Local-Bridge, Tunnel & Mesh
Per Radio Client Capacity	Up to 256	Up to 256
Cellular Co-existence**	Yes	Yes
Reset Button	Yes	Yes
LED Off Mode	Yes	Yes

* Frequency selection and power may be restricted to abide by regional regulatory compliance laws.

** Additional filtration added to reduce interference in 2.4 GHz band from nearby cellular equipment.



SPECIFICATIONS

	FORTIAP U321EV	FORTIAP U323EV
Advanced 802.11 Features		
802.11ac MU-MIMO Wave 2	Yes	Yes
Transmit Beam Forming (TxBF)	Yes	Yes
Low-Density Parity Check (LDPC) Encoding	Yes	Yes
Maximum Likelihood Demodulation (MLD)	Yes	Yes
Maximum Ratio Combining (MRC)	Yes	Yes
A-MPDU and A-MSDU Packet Aggregation	Yes	Yes
MIMO Power Save	Yes	Yes
Short Guard Interval	Yes	Yes
Wireless Monitoring Capabilities		
Rogue Scan Radio Modes	Background, Dedicated	Background, Dedicated
WIPS / WIDS Radio Modes	Background, Dedicated (recommended)	Background, Dedicated (recommended)
Packet Sniffer Mode	Yes	Yes
Spectrum Analyzer	Yes	Yes
Dimensions		
Length x Width x Height	8.58 × 8.58 × 1.69 inches (218 × 218 × 43 mm)	8.58 × 8.58 × 1.69 inches (218 × 218 × 43 mm)
Weight	2.24 lbs (1.02 kg)	2.25 lbs (1.02 kg)
Package (shipping) Weight	3.73 lbs (1.69 kg)	3.74 lbs (1.70 kg)
Mounting Options	Ceiling, T-Rail and Wall	Ceiling, T-Rail and Wall
Included Accessories	Mount kits for Ceiling, T-Rail and Wall	Mount kits for Ceiling, T-Rail and Wall, 6 dipole antennas
Environment		
Power Supply	SP-FAP200-PA-XX, GPI-115, or GPI-130	SP-FAP200-PA-XX, GPI-115, or GPI-130
Power Consumption (Maximum)	15 W when supplied by 802.3at power and 12.8 W when in 802.3af power mode (TX power limited to 20 dBm)	15 W when supplied by 802.3at power and 12.8 W when in 802.3af power mode (TX power limited to 20 dBm)
Humidity	5–90% non-condensing	5–90% non-condensing
Operating / Storage Temperature	32–122°F (0–50°C) / -40–158°F (-40–70°C)	32–122°F (0–50°C) / -40–158°F (-40–70°C)
Directives	Low Voltage Directive • RoHS	Low Voltage Directive • RoHS
UL2043 Plenum Material	No	No
Mean Time Between Failures	>30 Years	>30 Years
IP Rating	—	—
Surge Protection Built In	—	—
Hit-less PoE Failover	Yes	Yes
Certifications		
Wi-Fi Alliance Certified	Yes	Yes
DFS	FCC, IC, CE, Japan	FCC, IC, CE, Japan
Warranty		
Limited Lifetime Warranty	Yes	Yes



FAP-U321EV / FAP-U323EV RF RX/TX PERFORMANCE TABLE

FORTIAP U321EV AND U323EV				
802.11 a/g	Radio 1 2.4 GHz		Radio 2 5 GHz	
	Max Tx Power per transmit chain (dBm)	Rx Sensitivity per receiver chain (dBm)	Max Tx Power per transmit chain (dBm)	Rx Sensitivity per receiver chain (dBm)
6 Mbps	22	-91	20	-90
9 Mbps	22	-90	20	-89
12 Mbps	22	-87	20	-86
18 Mbps	22	-86	20	-85
24 Mbps	22	-81	20	-80
36 Mbps	22	-76	19	-75
48 Mbps	22	-75	19	-74
54 Mbps	19	-74	18	-73
802.11 HT20	Tx Power (dBm)	Rx Sensitivity (dBm)	Tx Power (dBm)	Rx Sensitivity (dBm)
MCS 0/8/16 (BPSK)	21	-90	19	-90
MCS 1/9/17 (QPSK)	21	-86	19	-87
MCS 2/10/18 (QPSK)	20	-83	19	-85
MCS 3/11/19 (16-QAM)	19	-82	18	-82
MCS 4/12/20 (16-QAM)	19	-77	17	-80
MCS 5/13/21 (64-QAM)	18	-75	17	-77
MCS 6/14/22 (64-QAM)	18	-73	17	-74
MCS 7/15/23 (64-QAM)	17	-70	16	-71
802.11 HT40	Tx Power (dBm)	Rx Sensitivity (dBm)	Tx Power (dBm)	Rx Sensitivity (dBm)
MCS 0/8/16 (BPSK)	21	-87	18	-88
MCS 1/9/17 (QPSK)	20	-87	18	-85
MCS 2/10/18 (QPSK)	20	-84	18	-85
MCS 3/11/19 (16-QAM)	19	-83	18	-80
MCS 4/12/20 (16-QAM)	19	-78	18	-78
MCS 5/13/21 (64-QAM)	18	-73	17	-74
MCS 6/14/22 (64-QAM)	18	-72	17	-71
MCS 7/15/23 (64-QAM)	18	-71	15	-68
MCS 8/16/24 (256-QAM)	-	-	15	-64
MCS 9/17/25 (256-QAM)	-	-	15	-61
802.11 HT80	Tx Power (dBm)	Rx Sensitivity (dBm)	Tx Power (dBm)	Rx Sensitivity (dBm)
MCS 0 (BPSK)	-	-	18	-83
MCS 1 (QPSK)	-	-	17	-80
MCS 2 (QPSK)	-	-	17	-78
MCS 3 (16-QAM)	-	-	16	-75
MCS 4 (16-QAM)	-	-	16	-73
MCS 5 (64-QAM)	-	-	15	-75
MCS 6 (64-QAM)	-	-	15	-72
MCS 7 (64-QAM)	-	-	15	-69
MCS 8 (256-QAM)	-	-	15	-61
MCS 9 (256-QAM)	-	-	15	-58

Maximum capability of the Hardware provided (Excluding antenna gain)



ANTENNA RADIATION PATTERNS

FAP-U321EV

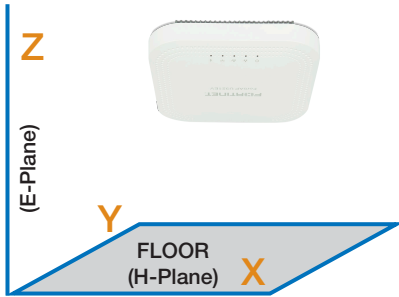

H-Plane Pattern

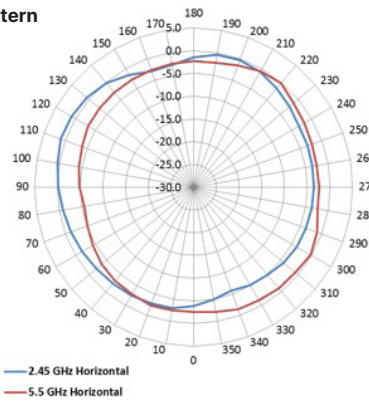

E-Plane Pattern

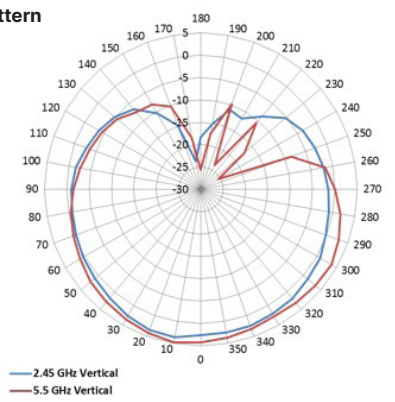

FAP-U323EV

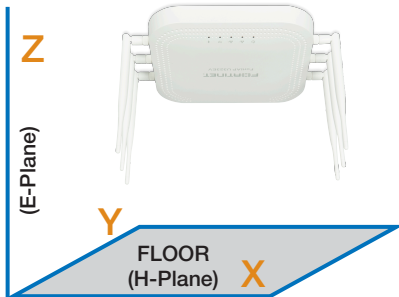

H-Plane Pattern

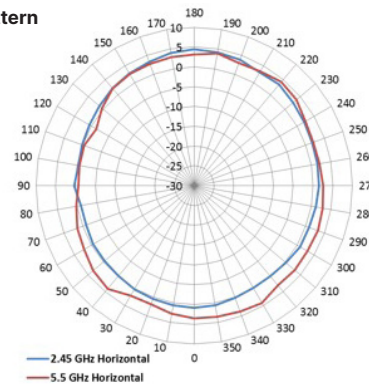

E-Plane Pattern

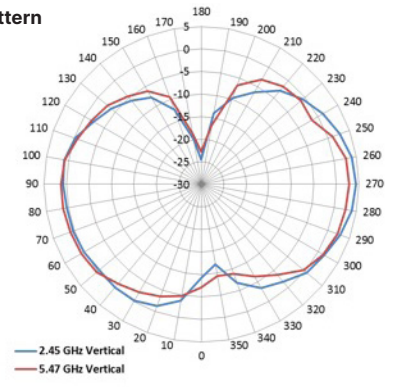

PERFORMANCE MATRIX

FAP-U321EV AND FAP-U323EV 802.11AC PERFORMANCE — DATA RATES (MBPS)							
Descriptor	Data Streams	VHT20		VHT40		VHT80	
		Normal GI	Short GI	Normal GI	Short GI	Normal GI	Short GI
MCS 0	1	6.5	7.2	13.5	15	29.3	32.5
MCS 1	1	13	14.4	27	30	58.5	65
MCS 2	1	19.5	21.7	40.5	45	87.8	97.5
MCS 3	1	26	28.9	54	60	117	130
MCS 4	1	39	43.3	81	90	175.5	195
MCS 5	1	52	57.8	108	120	234	260
MCS 6	1	58.5	65	121.5	135	263.3	292.5
MCS 7	1	65	72.2	135	150	292.5	325
MCS 8	1	78	86.7	162	180	351	390
MCS 9	1	NA	NA	180	200	390	433.3
MCS 0	2	13	14.4	27	30	58.5	65
MCS 1	2	26	28.9	54	60	117	130
MCS 2	2	39	43.3	81	90	175.5	195
MCS 3	2	52	57.8	108	120	234	260
MCS 4	2	78	86.7	162	180	351	390
MCS 5	2	104	115.6	216	240	468	520
MCS 6	2	117	130	243	270	526.5	585
MCS 7	2	130	144.4	270	300	585	650
MCS 8	2	156	173.3	324	360	702	780
MCS 9	2	NA	NA	360	400	780	866.7
MCS 0	3	19.5	21.7	40.5	45	87.8	97.5
MCS 1	3	39	43.3	81	90	175.7	195
MCS 2	3	58.5	65	121.5	135	263.3	292.5
MCS 3	3	78	86.7	162	180	351	390
MCS 4	3	117	130	243	270	526.5	585
MCS 5	3	156	173.3	324	360	702	780
MCS 6	3	175.5	195	364.5	405	NA	NA
MCS 7	3	195	216.7	405	450	877.5	975
MCS 8	3	234	260	486	540	1053	1170
MCS 9	3	260	286	540	600	1170	1300



HIGHLIGHTS

FortiAP U24JEV

The FortiAP U24JEV is an enterprise low cost next generation compact design 2×2 MU-MIMO 802.11ac Wave 1 Dual Band (2.4 GHz/5.0 GHz) wall plug/wall plate access point with an optionally available stand for desk mounting.



Note: This AP is not UTP capable.



802.11ac Wave 1 | 2×2 Radio capable of operating as Dual Band 1×1 Radios



2×2 | 2× 1×1 radios up to 867 Mbps

SPECIFICATIONS

FORTIAP U24JEV	
Hardware	
Hardware Type	Wall Plate AP
Number of Radios	1 (can operate as 2) + 1 BLE
Number of Antennas	2 Internal + 1 BLE Internal
Antenna Type and Peak Gain	Patch: 3 dBi for 2.4 GHz, 4 dBi for 5 GHz
Frequency Bands (GHz)	2.400–2.4835, 5.150–5.250, 5.250–5.350, 5.470–5.725, 5.725–5.850
Radio 1 Capabilities	2.4 GHz b/g/n (2×2:2 stream) 20/40 MHz (64 QAM) or 5 GHz a/n/ac (2×2:2 stream) 20/40/80 MHz (256 QAM) or 2.4 GHz b/g/n (1×1:1 stream) 20/40 MHz (64 QAM) & 5 GHz a/n/ac (1×1:1 stream) 20/40/80 MHz (256 QAM)
Radio 2 Capabilities	—
Maximum Data Rate	Up to 867 Mbps
Bluetooth Low Energy Radio	Bluetooth scanning and iBeacon advertisement @ 4 dBm max TX power
Interfaces	4× 10/100/1000 Base-T RJ45 Ports (1× 802.3at PoE (PD), 1× 802.3af PoE (PSE), 2x Non-PoE Ports), 1 Passthrough in RJ45, 1 Passthrough out RJ45
Power over Ethernet (PoE)	802.3af (max PSE output of 4W) or 802.3at (full 802.3af PSE output)
Simultaneous SSIDs	Up to 16 (14 if background scanning enabled)
EAP Type(s)	EAP-TLS, EAP-TTLS/MSCHAPv2, PEAPv0/EAP-MSCHAPv2, PEAPv1/EAP-GTC EAP-SIM, EAP-AKA, EAP-FAST
User/Device Authentication	WPA™, WPA2™, and WPA3™ with 802.1x or Preshared key, WEP, Web Captive Portal, MAC blacklist and allowlist
Maximum Tx Power (Conducted)	2.4 GHz: 23 dBm / 200 mW (2 chains combined)* or 5 GHz: 21 dBm / 126 mW (2 chains combined)*
Kensington Lock	No
IEEE Standards	802.11a, 802.11b, 802.11d, 802.11e, 802.11g, 802.11h, 802.11i, 802.11j, 802.11k, 802.11n, 802.11v, 802.11w, 802.11ac, 802.1Q, 802.1X, 802.3af, 802.3at, 802.3az, 802.3ad
SSID Types Supported	Local-Bridge, Tunnel
Per Radio Client Capacity	Up to 128
Cellular Co-existence**	Yes
Reset Button	Yes
LED Off Mode	Yes
Advanced 802.11 Features	
802.11ac MU-MIMO Wave 2	No
Transmit Beam Forming (TxBF)	Yes
Low-Density Parity Check (LDPC) Encoding	Yes

FORTIAP U24JEV	
Maximum Likelihood Demodulation (MLD)	Yes
Maximum Ratio Combining (MRC)	Yes
A-MPDU and A-MSDU Packet Aggregation	Yes
MIMO Power Save	Yes
Short Guard Interval	Yes
Wireless Monitoring Capabilities	
Rogue Scan Radio Modes	Background, Dedicated
WIPS / WIDS Radio Modes	Background, Dedicated (recommended)
Packet Sniffer Mode	Yes
Spectrum Analyzer	Yes
Dimensions	
Length x Width x Height	6.1 × 3.7 × 1.2 inches (155 × 95 × 31 mm)
Weight	0.569 lbs (0.258 kg)
Package (shipping) Weight	1.34 lbs (0.606 kg)
Mounting Options	Wall plate or desk stand
Included Accessories	Mounting kit for wall plate
Environment	
Power Supply	SP-FAPU24-PA-XX, GPI-115, or GPI-130
Power Consumption (Maximum)	24W (Depends on PoE connected and USB power consumed)
Humidity	10–90% non-condensing
Operating / Storage Temperature	32–104°F (0–40°C) / -22–158°F (-30–70°C)
Directives	RoHS
UL2043 Plenum Material	No
Mean Time Between Failures	>30 Years
IP Rating	—
Surge Protection Built In	—
Hit-less PoE Failover	No
Certifications	
Wi-Fi Alliance Certified	Yes
DFS	CE, Japan
Warranty	
Limited Lifetime Warranty	Yes

* Frequency selection and power may be restricted to abide by regional regulatory compliance laws.

** Additional filtration added to reduce interference in 2.4GHz band from nearby cellular equipment.



FAP-U24JEV RF RX/TX PERFORMANCE TABLE

FORTIAP U24JEV				
802.11 a/g	Radio 1 2.4 GHz		Radio 1 5 GHz	
	Max Tx Power per transmit chain (dBm)	Rx Sensitivity per receiver chain (dBm)	Max Tx Power per transmit chain (dBm)	Rx Sensitivity per receiver chain (dBm)
6 Mbps	20	-96	18	-94
9 Mbps	20	-94	18	-93
12 Mbps	20	-93	18	-92
18 Mbps	20	-91	18	-89
24 Mbps	20	-87	18	-86
36 Mbps	20	-84	18	-83
48 Mbps	20	-79	18	-78
54 Mbps	17	-78	15	-76
802.11 HT20	Tx Power (dBm)	Rx Sensitivity (dBm)	Tx Power (dBm)	Rx Sensitivity (dBm)
MCS 0/8/16 (BPSK)	19	-95	19	-90
MCS 1/9/17 (QPSK)	19	-93	19	-87
MCS 2/10/18 (QPSK)	19	-90	19	-85
MCS 3/11/19 (16-QAM)	19	-87	19	-82
MCS 4/12/20 (16-QAM)	18	-84	19	-80
MCS 5/13/21 (64-QAM)	17	-79	19	-77
MCS 6/14/22 (64-QAM)	17	-77	19	-74
MCS 7/15/23 (64-QAM)	16	-76	16	-71
802.11 HT40	Tx Power (dBm)	Rx Sensitivity (dBm)	Tx Power (dBm)	Rx Sensitivity (dBm)
MCS 0 (BPSK)	19	-93	18	-90
MCS 1 (QPSK)	19	-90	18	-87
MCS 2 (QPSK)	19	-88	18	-85
MCS 3 (16-QAM)	19	-84	18	-82
MCS 4 (16-QAM)	18	-81	18	-79
MCS 5 (64-QAM)	17	-76	17	-73
MCS 6 (64-QAM)	17	-75	16	-72
MCS 7 (64-QAM)	16	-73	15	-73
MCS 8 (256-QAM)	-	-	15	-67
MCS 9 (256-QAM)	-	-	15	-66
802.11 HT80	Tx Power (dBm)	Rx Sensitivity (dBm)	Tx Power (dBm)	Rx Sensitivity (dBm)
MCS 0 (BPSK)	-	-	17	-87
MCS 1 (QPSK)	-	-	17	-83
MCS 2 (QPSK)	-	-	17	-81
MCS 3 (16-QAM)	-	-	16	-78
MCS 4 (16-QAM)	-	-	16	-75
MCS 5 (64-QAM)	-	-	15	-73
MCS 6 (64-QAM)	-	-	15	-70
MCS 7 (64-QAM)	-	-	15	-68
MCS 8 (256-QAM)	-	-	14	-64
MCS 9 (256-QAM)	-	-	14	-62

Maximum capability of the Hardware provided (Excluding antenna gain)



ANTENNA RADIATION PATTERNS — WALL MOUNT

FAP-U24JEV



**H-Plane Pattern
with metal mounting
plate**

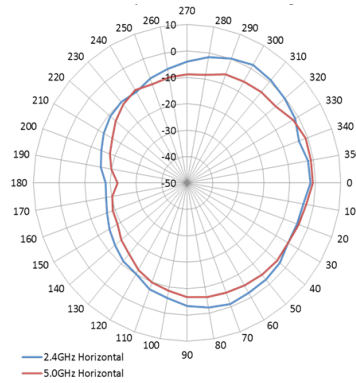

**E-Plane Pattern
with metal mounting plate**

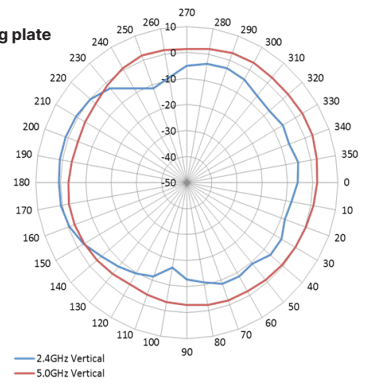

**H-Plane Pattern
without metal mounting plate**

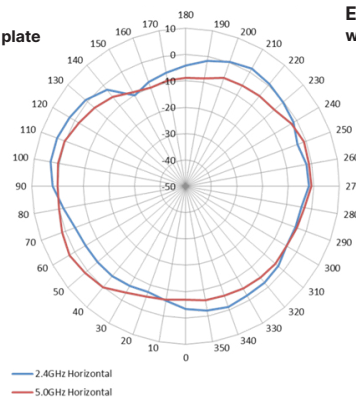

**E-Plane Pattern
without metal mounting plate**

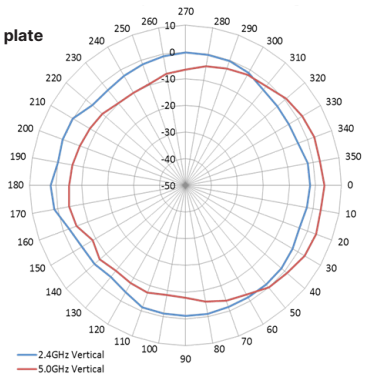

ORDER INFORMATION

PRODUCT	SKU	DESCRIPTION
FortiAP U431F	FAP-U431F	Indoor Wireless UTP AP - Tri radio (2x 802.11 a/b/g/n/ac/ax, 4x4 MIMO and 1x 802.11 a/b/g/n/ac Wave 2, 2x2 MU-MIMO), internal antennas, 1x 10/100/1000/2500 Base-T RJ45, 1x 10/100/1000 Base-T RJ45, BT/BLE, 1x Type A USB, 1x RS-232 RJ45 Serial Port. Ceiling/wall mount kit included. For power order: 802.3at PoE injector GPI-130 or AC adapter SP-FAP43F-PA-X-5
	FC-10-90APU-443-02-DD	FortiAP-U Series FortiGuard Universal Threat Protection Subscription Service License. Applicable to FortiGate or FortiLAN Cloud managed F-Series or later FortiAP-U family Access Points.
	FC-10-P431F-247-02-DD	24x7 FortiCare Contract
FortiAP U432F	FAP-U432F	Outdoor Universal AP - Tri radio (1x 2.4GHz/5GHz 4x4 Wi-Fi 6, 1x 5GHz 4x4 Wi-Fi 6, 1x 2.4GHz/5GHz 1x1 Wi-Fi 5), external antennas included, 1x 100/1000/2500 RJ45, 1x 10/100/1000 RJ45, IoT Enabled (BT/BLE), 1x RS-232 RJ45 Serial Port. Pole/wall mount kit and PoE injector included.
	FC-10-90APU-443-02-DD	FortiAP-U Series FortiGuard Universal Threat Protection Subscription Service License. Applicable to FortiGate or FortiLAN Cloud managed F-Series or later FortiAP-U family Access Points.
	FC-10-PU432-247-02-DD	24x7 FortiCare Contract
FortiAP U433F	FAP-U433F	Indoor Wireless UTP AP - Tri radio (2x 802.11 a/b/g/n/ac/ax, 4x4 MIMO and 1x 802.11 a/b/g/n/ac Wave 2, 2x2 MU-MIMO), external antennas included, 1x 10/100/1000/2500 Base-T RJ45, 1x 10/100/1000 Base-T RJ45, BT/BLE, 1x Type A USB, 1x RS-232 RJ45 Serial Port. Ceiling/wall mount kit included. For power order: 802.3at PoE injector GPI-130 or AC adapter SP-FAP43F-PA-X-5
	FC-10-90APU-443-02-DD	FortiAP-U Series FortiGuard Universal Threat Protection Subscription Service License. Applicable to FortiGate or FortiLAN Cloud managed F-Series or later FortiAP-U family Access Points.
	FC-10-P433F-247-02-DD	24x7 FortiCare Contract
FortiAP U231F	FAP-U231F	Indoor Wireless UTP AP - Tri radio (802.11 b/g/n/ax 2x2 MU-MIMO, 802.11 a/n/ac/ax 2x2 MU-MIMO and 1x 802.11 a/b/g/n/ac Wave 2, 1x1), internal antennas, 2x 10/100/1000 RJ45 port, BT/BLE, 1x Type A USB, 1x RS-232 RJ45 Serial Port. Ceiling/wall mount kit included. For power order: SP-FAP250-PA-10.
	FC-10-90APU-443-02-DD	FortiAP-U Series FortiGuard Universal Threat Protection Subscription Service License. Applicable to FortiGate or FortiLAN Cloud managed F-Series or later FortiAP-U family Access Points.
	FC-10-P231-247-02-DD	24x7 FortiCare Contract
FortiAP U234F	FAP-U234F	Outdoor Universal AP - Tri radio (1x 2.4GHz/5GHz 2x2 Wi-Fi 6, 1x 5GHz 2x2 Wi-Fi 6, 1x 2.4GHz/5GHz 2x2 Wi-Fi 5), internal antennas, 2x 10/100/1000 RJ45, IoT Enabled (BT/BLE), 1x RS-232 RJ45 Serial Port. Pole/wall mount kit and PoE injector included.
	FC-10-90APU-443-02-DD	FortiAP-U Series FortiGuard Universal Threat Protection Subscription Service License. Applicable to FortiGate or FortiLAN Cloud managed F-Series or later FortiAP-U family Access Points.
	FC-10-PU234-247-02-DD	24x7 FortiCare Contract
FortiAP U421EV	FAP-U421EV	Indoor Wireless AP - Dual radio (802.11 a/b/g/n and 802.11 a/b/g/n/ac Wave 2, 4x4 MU-MIMO), internal antennas, 2 x 10/100/1000 RJ45 port. Ceiling/wall mount kit included. For power order: 802.3af PoE injector GPI-115 (limited features) or 802.3at PoE injector GPI-130 or AC adapter SP-FAP400-PA.
	FC-10-P0421-247-02-DD	24x7 FortiCare Contract
FortiAP U423EV	FAP-U423EV	Indoor Wireless AP - Dual radio (802.11 a/b/g/n and 802.11 a/b/g/n/ac Wave 2, 4x4 MU-MIMO), external antennas included, 2 x 10/100/1000 RJ45 port. Ceiling/wall mount kit included. For power order: 802.3af PoE injector GPI-115 (limited features) or 802.3at PoE injector GPI-130 or AC adapter SP-FAP400-PA.
	FC-10-P0423-247-02-DD	24x7 FortiCare Contract
FortiAP U422EV	FAP-U422EV	Outdoor Wireless AP - Dual radio (802.11 a/b/g/n and 802.11 a/b/g/n/ac Wave 2, 4x4 MU-MIMO), external antennas included, 2 x 10/100/1000 RJ45 port, IP67 rated. Pole/wall mount kit, ground cable, power supply included.
	FC-10-P0422-247-02-DD	24x7 FortiCare Contract
FortiAP U321EV	FAP-U321EV	Indoor Wireless AP - Dual radio (802.11 a/b/g/n and 802.11 a/n/ac Wave 2, 3x3 MU-MIMO), internal antennas, 2 x 10/100/1000 RJ45 port, BT / BLE. Ceiling/wall mount kit included. For power order: 802.3af PoE injector GPI-115 (limited features) or 802.3at PoE injector GPI-130 or AC adapter SP-FAP200-PA.
	FC-10-PU321-247-02-DD	24x7 FortiCare Contract
FortiAP U323EV	FAP-U323EV	Indoor Wireless AP - Dual radio (802.11 a/b/g/n and 802.11 a/n/ac Wave 2, 3x3 MU-MIMO), external antennas included, 2 x 10/100/1000 RJ45 port, BT / BLE. Ceiling/wall mount kit included. For power order: 802.3af PoE injector GPI-115 (limited features) or 802.3at PoE injector GPI-130 or AC adapter SP-FAP200-PA.
	FC-10-PU323-247-02-DD	24x7 FortiCare Contract



ORDER INFORMATION

PRODUCT	SKU	DESCRIPTION
FortiAP U24JEV	FAP-U24JEV	Wall Plate AP - Single radio [can be configured as two] (802.11 a/b/g/n/ac, 2x2 MIMO 2.4GHz/5GHz or 1x1 SISO 2.4GHz and 1x1 SISO 5GHz), internal antennas, 4 x 10/100/1000 RJ45 port (1x 802.3at PoE PD, 1x 802.3af PoE PSE, 2x Non-PoE Ports). Mounting bracket included. For power order: 802.3af PoE injector GPI-115 (limited features) or 802.3at PoE injector GPI-130 or AC adapter SP-FAPU24-PA.
	FC-10-P024E-247-02-DD	24x7 FortiCare Contract
	FAP-MNT-WJ-20	Optional desk mount.
Gigabit PoE Injector	GPI-115	1-Port Gigabit PoE Injector, 802.3af up to 12.95 W.
	GPI-130	1-Port Gigabit PoE Power Injector, 802.3at up to 30W.
Power Adapter	SP-FAP43F-PA-X-5	AC power adapter for FAP-U431F and FAP-U433F.
	SP-FAP400-PA	AC power adapter for FAP-U421EV and FAP-U423EV.
	SP-FAP200-PA	AC power adapter for FAP-U321EV, and FAP-U323EV.
	SP-FAPU24-PA	AC power adapter for FAP-U24JEV.
	SP-FAP250-PA-10	AC power adapter with US and EU plugs for FAP-U231F and FAP-231F.
FORTIGUARD SERVICES		
	FC-10-90APU-443-02-DD	FortiAP-U Series FortiGuard Universal Threat Protection Subscription Service License. Applicable to FortiGate or FortiLAN Cloud managed F-Series or later FortiAP-U family Access Points.

Additional external antenna options are available for some models. Please see the antenna datasheet for details.

Note: A country suffix code (-A, -B, -C, -D, -E, -F, -I, -J, -K, -N, -P, -S, -T, -U, -V, -W, or -Y) applies to all AP models based upon country of deployment. Work with your local supplier for the correct model in your regulatory domain.



www.fortinet.com

Copyright © 2021 Fortinet, Inc. All rights reserved. Fortinet®, FortiGate®, FortiCare® and FortiGuard®, and certain other marks are registered trademarks of Fortinet, Inc., and other Fortinet names herein may also be registered and/or common law trademarks of Fortinet. All other product or company names may be trademarks of their respective owners. Performance and other metrics contained herein were attained in internal lab tests under ideal conditions, and actual performance and other results may vary. Network variables, different network environments and other conditions may affect performance results. Nothing herein represents any binding commitment by Fortinet, and Fortinet disclaims all warranties, whether express or implied, except to the extent Fortinet enters a binding written contract, signed by Fortinet's General Counsel, with a purchaser that expressly warrants that the identified product will perform according to certain expressly-identified performance metrics and, in such event, only the specific performance metrics expressly identified in such binding written contract shall be binding on Fortinet. For absolute clarity, any such warranty will be limited to performance in the same ideal conditions as in Fortinet's internal lab tests. Fortinet disclaims in full any covenants, representations, and guarantees pursuant hereto, whether express or implied. Fortinet reserves the right to change, modify, transfer, or otherwise revise this publication without notice, and the most current version of the publication shall be applicable.