

# Product datasheet

Specifications



## circuit breaker EasyPact EZC250H - TMD - 125 A - 4 poles 3d

EZC250H4125

### Main

Range of product	EasyPact
Product or component type	Circuit breaker
Device short name	EasyPact EZC250H
Circuit breaker name	EasyPact EZC250H
Device application	Distribution
Poles description	4P
Protected poles description	3t
Network type	AC DC
Network frequency	50/60 Hz
[In] rated current	125 A at 40 °C
[Ui] rated insulation voltage	690 V AC 50/60 Hz conforming to IEC 60947-2
[Uimp] rated impulse withstand voltage	6 kV conforming to IEC 60947-2
[Ue] rated operational voltage	550 V AC 50/60 Hz conforming to IEC 60947-2 250 V DC conforming to IEC 60947-2
Breaking capacity code	H
Breaking capacity	10 kA Icu at 550 V AC 50/60 Hz conforming to IEC 60947-2 25 kA Icu at 440 V AC 50/60 Hz conforming to IEC 60947-2 30 kA Icu at 125 V DC 1P conforming to IEC 60947-2 30 kA Icu at 250 V DC 2P conforming to IEC 60947-2 85 kA Icu at 220...240 V AC 50/60 Hz conforming to IEC 60947-2 36 kA Icu at 380...415 V AC 50/60 Hz conforming to IEC 60947-2
[Ics] rated service breaking capacity	5 kA at 550 V AC 50/60 Hz conforming to IEC 60947-2 15 kA at 125 V DC conforming to IEC 60947-2 15 kA at 250 V DC conforming to IEC 60947-2 12.5 kA at 440 V AC 50/60 Hz conforming to IEC 60947-2 18 kA at 380...415 V AC 50/60 Hz conforming to IEC 60947-2 42.5 kA at 220...240 V AC 50/60 Hz conforming to IEC 60947-2
Suitability for isolation	Yes conforming to IEC 60947-2
Utilisation category	Category A
Trip unit name	TM-D
Trip unit technology	Thermal-magnetic
Trip unit rating	125 A at 50 °C
Protection type	Overload protection Short-circuit protection

Pollution degree	3 conforming to IEC 60947
------------------	---------------------------

## Complementary

Control type	Toggle
Mounting mode	Fixed
Mounting support	Backplate
Upside connection	Front
Downside connection	Front
Mechanical durability	10000 cycles
Electrical durability	Category A: 5000 cycles 415 V AC 50/60 Hz conforming to IEC 60947-2
Connection pitch	35 mm
Local signalling	Positive contact indication
Neutral protection setting	Without protection
Earth-leakage protection	Without
Height	165 mm
Width	140 mm
Depth	60 mm

## Environment

Standards	EN/IEC 60947-1 EN/IEC 60947-2 JIS C8201-2-2 GB/T 14048.2
IP degree of protection	IP20 conforming to IEC 60529
IK degree of protection	IK07 conforming to EN 50102
Ambient air temperature for operation	-25...70 °C
Ambient air temperature for storage	-35...85 °C

## Packing Units

Unit Type of Package 1	PCE
Number of Units in Package 1	1
Package 1 Height	11.4 cm
Package 1 Width	11.3 cm
Package 1 Length	18.0 cm
Package 1 Weight	2.24 kg
Unit Type of Package 2	S03
Number of Units in Package 2	6
Package 2 Height	30.0 cm
Package 2 Width	30.0 cm
Package 2 Length	40.0 cm
Package 2 Weight	13.927 kg

## Offer Sustainability

Sustainable offer status	Green Premium product
--------------------------	-----------------------

<b>REACH Regulation</b>	<a href="#">REACH Declaration</a>
<b>REACH free of SVHC</b>	Yes
<b>EU RoHS Directive</b>	Compliant <a href="#">EU RoHS Declaration</a>
<b>Toxic heavy metal free</b>	Yes
<b>Mercury free</b>	Yes
<b>China RoHS Regulation</b>	<a href="#">China RoHS declaration</a>
<b>RoHS exemption information</b>	Yes
<b>Environmental Disclosure</b>	<a href="#">Product Environmental Profile</a>
<b>WEEE</b>	The product must be disposed on European Union markets following specific waste collection and never end up in rubbish bins

## Contractual warranty

<b>Warranty</b>	12 months
-----------------	-----------

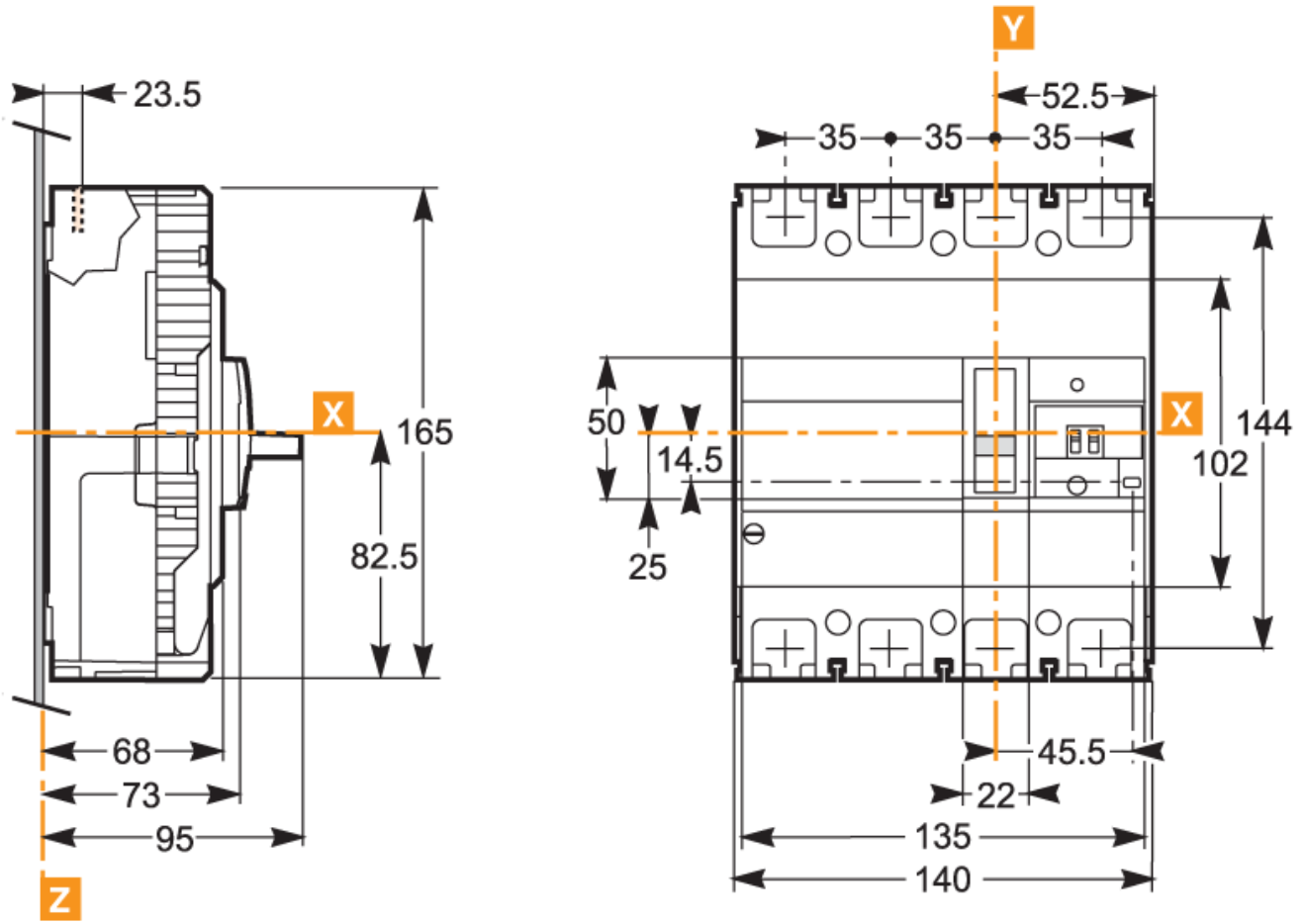

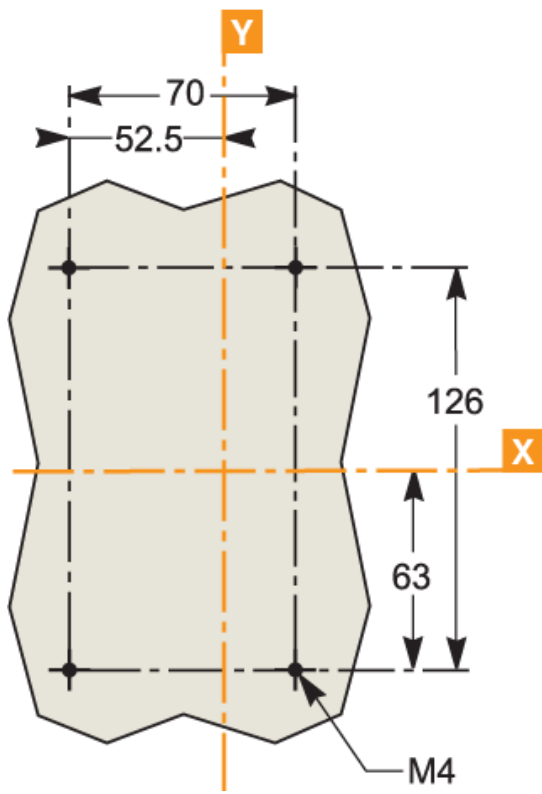

Performance Curves

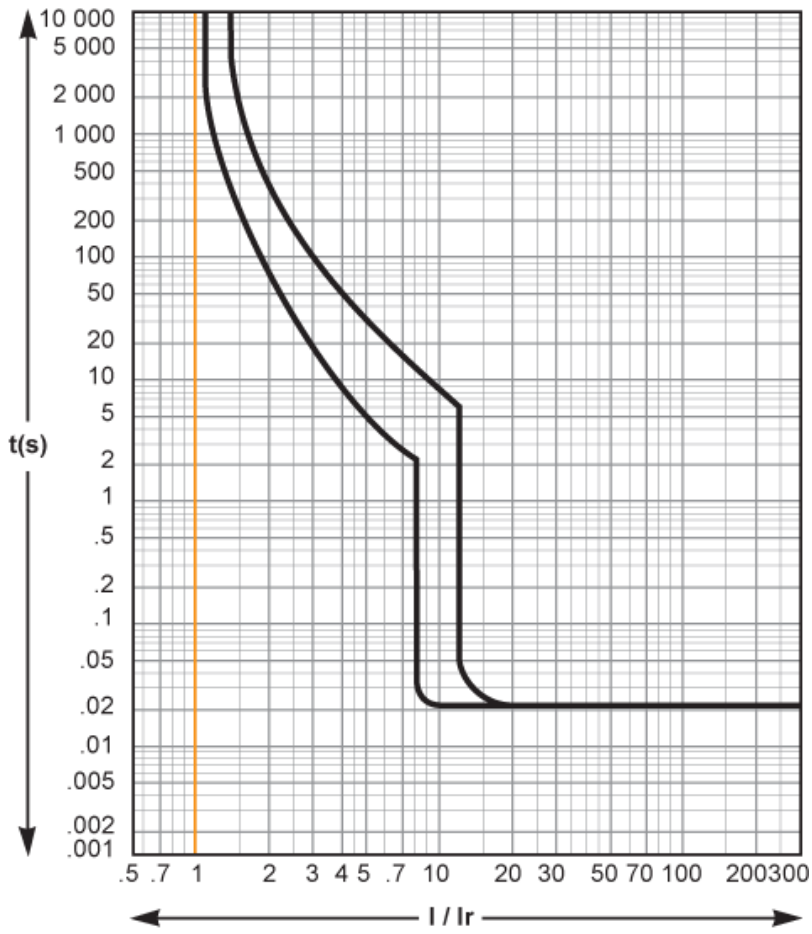

Recommended replacement(s)